

**M2I Corporation**

**Industrial BOX-HMI**

**TOPRP1000D**

**Hardware Manual**

---

Thank you for purchasing the industrial BOX-HMI series of M2I corporation.

Please read this manual carefully to know installing, wiring operating this equipment for safe use of this product.





# Contents

Contents.....	2
Chapter 1 Safety Precautions.....	3
Chapter 2 Overview .....	5
2.1 Introduction of Products.....	5
2.2 Package Contents.....	5
2.3 Explanation of Model Name .....	5
Chapter 3 General Specifications .....	6
3.1 Power Specifications .....	6
3.2 Memory Specifications.....	6
3.3 HDMI Output.....	6
3.4 Environment Specifications.....	6
3.5 Structure Specifications .....	6
Chapter 4 Part Names and General Specifications.....	7
4.1 TOPRP1000D.....	7
4.2 Product Dimension .....	7
4.3 Part Names and General Specifications.....	7
Chapter 5 External Device Interface .....	8
5.1 Serial Communication Specifications .....	8
5.2 Ethernet Communication Specifications .....	9
5.3 USB Specifications.....	10
5.4 HDMI Specifications .....	10
Chapter 6 Installation .....	11
6.1 Location Select for Installation.....	11
6.2 DIN RAIL Mounting and VESA bracket bonding.....	11
Chapter 7 Wiring .....	12
7.1 Power Cable Wiring.....	12
7.2 Ground Wiring .....	13
7.3 Installation of Cable Clamp .....	14
Chapter 8 Maintenance .....	14
8.1 Case Cleaning.....	14
8.2 Periodic Check Points.....	14
8.3 Problems with the Device.....	15
8.4 Setting System Recovery Mode.....	15
Chapter 9 Products Label .....	16











## Chapter 1 Safety Precautions

### ■ Before using the product





To use the product safely and effectively, please read the contents of this manual thoroughly before use. Please keep to the safety precaution, for it is to prevent accidents and potential danger from occurring. Safety precaution is classified into 'Warning' and 'Caution' and their meanings are as follows. Also the indicated illustrations on the product and in the manual have the following meanings.

 <b>Warning</b>	Violating the instruction may result in serious personal injury or death.
 <b>Caution</b>	Violating the instruction may result in slight personal injury or product damage.
	Be cautious, for danger may be present.
	Be cautious, for there is a possibility of an electric shock.



### ■ General Precautions

-  Do not press the screen with a hard or sharp object (awl, screwdriver, pen) with too strong a force.  
It may cause malfunction of touch due to damage of the front sheet.
-  Do not use or store in an environment with high vibration.
-  Do not allow foreign objects such as water, liquids, or metal powders to enter the product. This may cause breakage or electric shock.
-  Do not allow foreign objects such as water, liquids, or metal powders to enter into the product.
-  Use the radio or mobile phone at least 30cm away from the main unit.
-  Two or fewer bright spots may appear on the LCD screen, and certain areas may appear brighter, but this is not a defect in LCD characteristics.
-  Do not store or operate in direct sunlight. Direct sunlight can change the properties of the LCD.
-  Do not touch an adaptor or power cord with wet hands. It can cause electric shock.
-  Do not use this product in explosive environments with flammable liquid, gas, or dust.
-  If the product needs long-term storage without using, avoid direct sunlight and keep dry condition.

### ■ Design Precautions Warning

-  For protecting whole control system from outer power input or malfunction of product, protection circuit must be installed outside of product.
-  Physical protection devices as emergency switch, limit switch, or motion interlock circuit and others to prevent a critical damage of whole system's safety and human accident from the product's malfunction.
-  When computers or other outer devices control (operation mode change) the product, set interlock in sequence program to protect from any communication errors.
-  Input/output signals or communication cables must have at least 100mm(3.94inch) distance from power cable or high-tension wire. Especially communication cables must be set apart from power cables.

### ■ Wiring Precautions Warning

-  Be sure the wiring is done correctly by checking the product's rated voltage and the terminal layout. Incorrect wiring could result in fire, damage or malfunctions.
-  Tighten the terminal screw with the specified torque. If the screws of terminal are loose, it could result in short circuit, fire, malfunctions. FG Terminal must be used a dedicated ground. Not doing so could result in

malfunctions.

- ❗ a. Grounding should be the Class 3 grounding. The cable for grounding should be more than 4mm<sup>2</sup>.
- ❗ b. grounding point be closed to the products and make short the distance to the ground cable if possible.

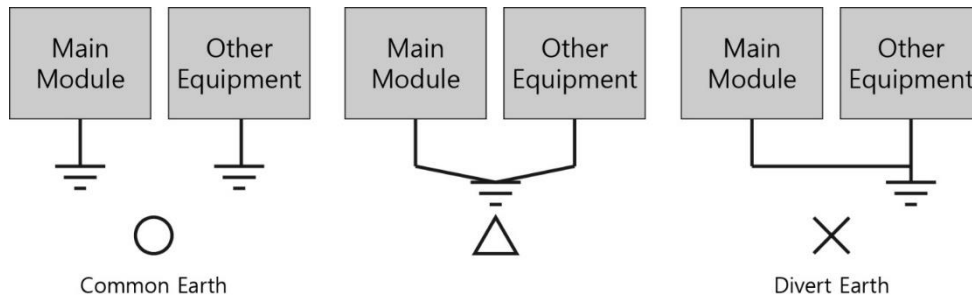

Fig. Grounding Example Diagram

**■ Installation Precautions** ⚠ Caution

- ⊘ Do not install the location which exceeds allowed temperature. Product can be damaged or shorten the life. Especially Install environment as below should be avoided.
- ⊘ Do not Install product to the place which the ambient temperature is out of limits, from -10°C to 50°C or on the surface of control board which high pressure equipment is installed.
- ⊘ Do not install to the place where strong shock or vibration continuously have impacted on product.
- ❗ If the product is left without using in long-term, it must be recharged and stored in room temperature.
- ⊘ The space between back of product and back of control board must be more than 100mm for maintenance and ventilation.
- ⊘ Use the product indoors only.
- ⊘ Use the product under 2000M altitude.
- ⊘ Power cable's length should be 3M(10 ft) or shorter.

**■ Disposal Precautions** ⚠ Caution

When you dispose of product and battery, please treat it as industrial waste. It can create poisonous substances or explosion.

**■ Cell Type Battery Specifications and Exchange** ⚠ Caution

Mounted on mainboard Model MS920SE Battery is not replaced by the user. If the battery has run out of service, please contact our Customer Support Center for replacement and inspection.

Item	Content
Battery Voltage	DC 3V
Battery Model	MS920SE (lithium / Rechargeable)
Battery lifetime	Permanent (In case of ambient temperature 25°C)

\* Depending on the model specifications are subject to change.

■ All field-wiring connections to this unit shall be from Limited Voltage / Limited Current, below 24Vdc isolated secondary source with an output fuse, or Class 2.

## Chapter 2 Overview





### 2.1 Introduction of Products

This BOX-HMI is an industrial control device in the field, with the basic purpose of communications and controls with other devices by RS-232C, RS-422/485, or Ethernet. Also this product can check the management status by connecting to outer display device.

### 2.2 Package Contents

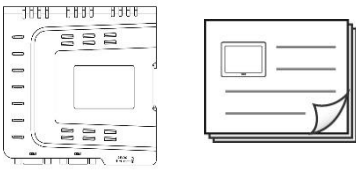
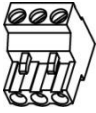
The components of the product are as follows.

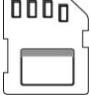
Before using the product, please check that all of the following components are included.

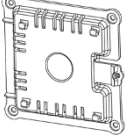
Item	Figure	Quantity
Product and User Manual		1
Power Connector		1
Accessories (Sold separate)	 USB Memory  USB Cable  SD Card  케이블 고정 클램프  VESA 고정 브라켓	User Options

### 2.3 Explanation of Model Name

Base Unit	Option	Power
TOPRP	1000: Default	D: DC

## Chapter 3 General Specifications

### 3.1 Power Specifications

Input Voltage	DC 24V
Input Voltage Range	DC 20 ~ 28V
Consumption Power	10W or less
Voltage endurance	DC 24V, within 10ms
Insulation Resistance	500V DC, 10 MΩ

### 3.2 Memory Specifications

Screen Memory	128MB
Backup Memory	512KB: System buffer (10K Word), Including Alarm/Log/Recipe
Backup Period	Permanent
Real Time Clock	Built in (by Battery)

### 3.3 HDMI Output

HDMI Version	HDMI v1.4a
Resolution	1280 x 720, 1024x768, 640x480 (Set in TDS S/W)

### 3.4 Environment Specifications

Operation Temperature (°C)	-10 ~ +50
Storage Temperature (°C)	-20 ~ +60
Operation Humidity (%RH)	0 ~ 90 (No dew)
Atmosphere	No corrosive gas
Vibration Endurance	Amplitude: 10≤F < 25Hz(2G) X,Y,Z each direction(for 30 minutes)
Noise Immunity	1000Vp-p(Pulse width 1μs)
Static Electricity Discharge	Connective discharge from EN61000-4-2: ±4kV
Shock Endurance	10G X,Y,Z each direction(for 3 times)
Surge Voltage	500V(Line-Line)
Ground Connection	Class 3(Under 100Ω)
Protection Classification	IP20

### 3.5 Structure Specifications

Weight (Kg)	0.23
Cooling System	Natural Air Circulation
Installation	Standard DIN Rail(35mm), VESA
Case Material	PC(Flameless)

# Chapter 4 Part Names and General Specifications

## 4.1 TOPRP1000D

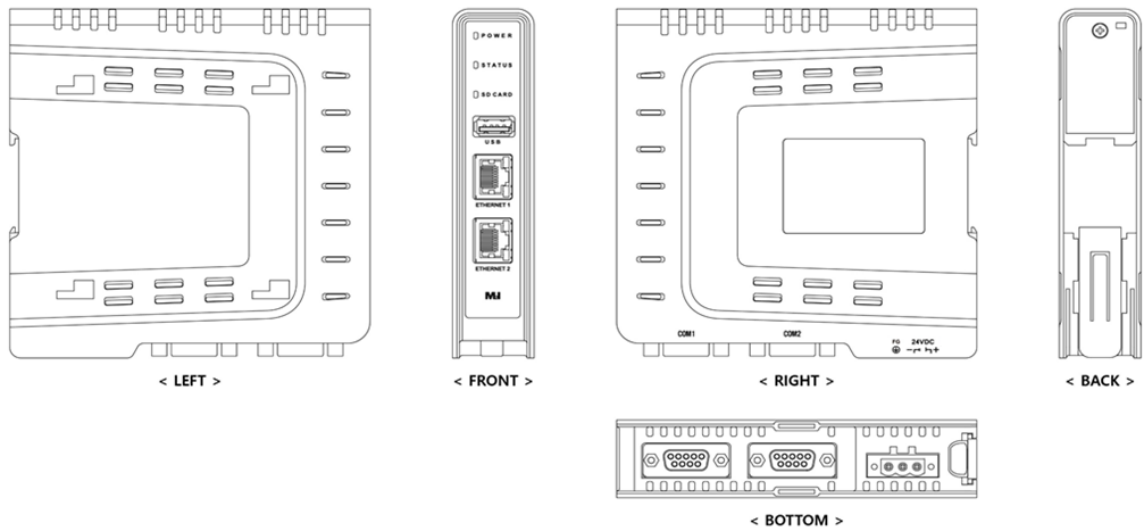

## 4.2 Product Dimension

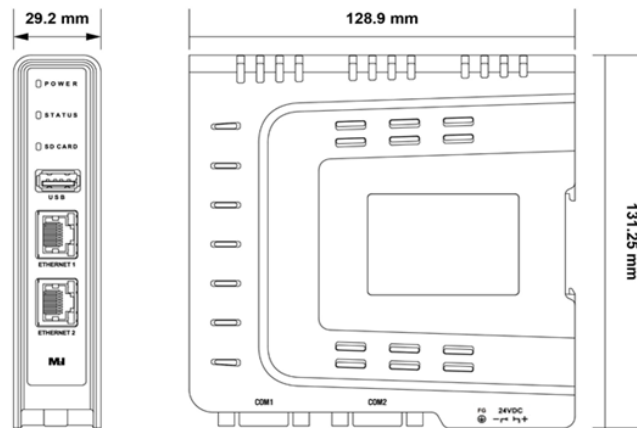

## 4.3 Part Names and General Specifications

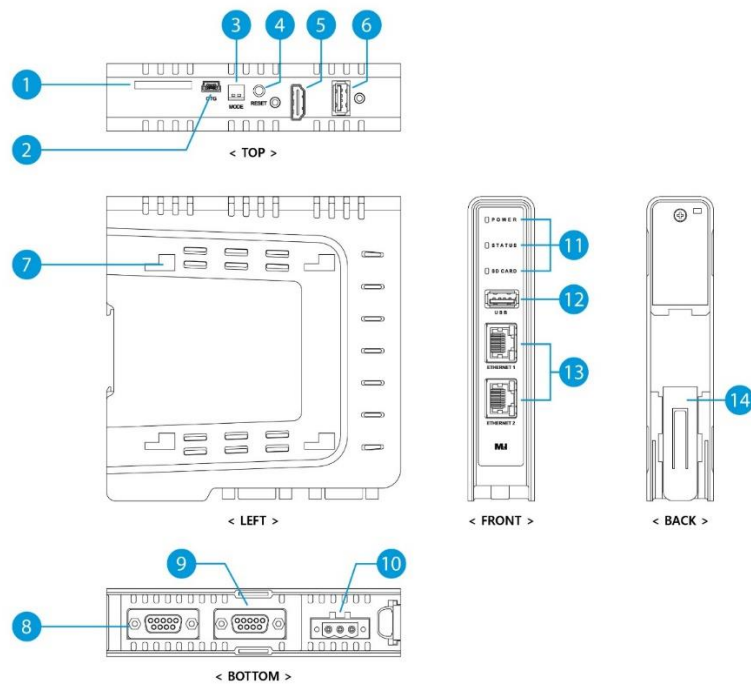

No	Name	Form	Description
1	SD Card Socket	SD Card Socket	SD Memory card
2	USB OTG	Mini-USB	Upload/Download port for project (*Only for Inner program management)
3	Mode Switch	DIP Switch	System mode selection switch
4	Reset Switch	Tact Switch	System reset switch
5	HDMI	Standard HDMI	HDMI Out port, Connecting to outer display device. (TV/Monitor) *Max. Resolution 1280 x 720
6	USB HOST #1	USB A type	USB Connecting Port, 5V/0.5A Output
7	VESA Bracket	-	VESA hole for installation
8	COM1	DSUB9 (Female)	RS-232C/422/485 (Selection by S/W)
9	COM2	DSUB9 (Female)	RS-232C/422/485 (Selection by S/W)
10	Power Input	TB 5mm 3P	Power Input
11	Status LED	3 LEDs	Status display of Power, Operation, and SD Card
12	USB HOST #2	USB A type	USB Connecting Port, 5V/0.5A Output
13	ETHERNET Port	RJ45 2ch	10BASE-T/100BASE-TX, Auto-MDIX
14	DIN RAIL	-	DIN RAIL Holding Bracket (35mm)

## Chapter 5 External Device Interface

In order for the main unit to communicate with an external device, it is necessary to connect the two devices by referring to the following.

### 5.1 Serial Communication Specifications

#### 5.1.1 RS-232C

Items		Contents
Protocol		Full Duplex
Synch		Asynchronous
Communication Distance		About 15m
Type of Connection		1:1
Control Code		ASCII Code or HEXA Code
Transmission Speed		2400,4800,9600,19200,38400,57600,76800, 115200 bps
Data Type	Data Bit	7, 8 bit
	Parity Bit	NONE, ODD, EVEN Parity
	Stop Bit	1, 2 bit
Modular Jack		DSUB 9pin

#### 5.1.2 RS-422/485

Items		Contents
Protocol		Full Duplex/Half Duplex
Synch		Asynchronous
Communication Distance		About 500m
Type of Connection		1:N(N ≤ 31)
Control Code		ASCII Code or HEXA Code



Transmission Speed		2400,4800,9600,19200,38400,57600,76800, 115200 bps
Data Type	Data Bit	7, 8 bit
	Parity Bit	NONE, ODD, EVEN Parity
	Stop Bit	1, 2 bit
Modular Jack		DSUB 9pin

### 5.1.3 COM1 Connector pin number and Signal name

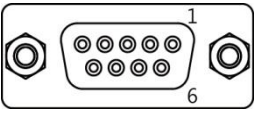
Type	Pin No.	Signal	Direction	Meaning
9Pin Female 	1	RDA(RD+)	Input	RS-422/485 Receive Data (+)
	2	RD(RxD)	Input	RS-232C Receive Data
	3	SD(TxD)	Output	RS-232C Send Data
	4	RDB(RD-)	Input	RS-422/485 Receive Data (-)
	5	SG	-	Signal Ground
	6	SDA(SD+)	Output	RS-422/485 Send Data (+)
	7	*1)Power	-	+5V , 0.2A
	8	*2)GND	-	Power Ground
	9	SDB(SD-)	Output	RS-422/485 Send Data (-)

\*1, \*2) When need VCC for external equipment, use 7.VCC and 8.VCC GND that output is 0.2A.

### 5.1.4 COM2 Connector pin number and Signal name

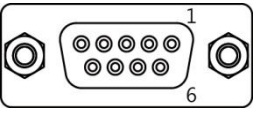
Type	Pin No.	Signal	Direction	Meaning
9Pin Female 	1	RDA(RD+)	Input	RS-422/485 Receive Data (+)
	2	RD(RxD)	Input	RS-232C Receive Data
	3	SD(TxD)	Output	RS-232C Send Data
	4	RDB(RD-)	Input	RS-422/485 Receive Data (-)
	5	SG	-	Signal Ground
	6	SDA(SD+)	Output	RS-422/485 Send Data (+)
	7	RTS	Output	RS-232C Send Request Signal
	8	CTS	Input	RS-232C Send Available Signal
	9	SDB(SD-)	Output	RS-422/485 Send Data (-)

\* Be sure to connect the RD and SD to the RS-232C communication line by crossing each other with a Twisted Pair Cable. Please connect SG directly.

\* SG must be connected directly.

\* RS-422/485 communication line must use RDA and RDB as Twisted Pair Cable, SDA and SDB as Twisted Pair Cable.

\* Do not use shield wire of communication line as signal ground. It may cause communication failure.

## 5.2 Ethernet Communication Specifications

### 5.2.1 Ethernet

Items	Contents
Ethernet Method	IEEE802.3i/IEEE802.3u, 10BaseT / 100BaseT
Speed	10M / 100Mbps
Communication Method	Base Band
Switching Method	AUTO MDIX

Maximum Segment Length	100M (Hub between products)
Communication Cable	UTP (Unshielded Twisted Pair)
Modular Jack	RJ45

### 5.2.2 RJ-45 Pin Map

Type	Pin No.	Color	Signal
	1	Orange/White	TD+
	2	Orange	TD-
	3	Green/White	RD+
	4	Blue	Not Available in 10BaseT
	5	Blue/White	Not Available in 10BaseT
	6	Green	RD-
	7	Brown/White	Not Available in 10BaseT
	8	Brown	Not Available in 10BaseT

\* When HUB is using, Straight cable should be used.

Ex) Straight Cable Wiring: Connect 1:1 according to the wiring diagram above.

\* In case of do not using HUB, do not use HUB, when it is connected directly, Cross Cable should be used.

Ex) Cross Cable Wiring: In the above wiring diagram, TD+ and RD+ are changed, and TD- and RD- are exchanged.

## 5.3 USB Specifications

### 5.3.1 USB Host

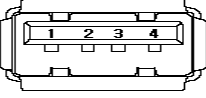
Type	Item	Specification
	USB Interface	EHCI/OHCI Specification Version 1.0, USB2.0/1.1 compatible
	Communication Method	Control/Bulk
	Transfer Speed	480Mb/s
	Support Device	USB Storage (FAT16/FAT32 File Format Available)
	Connector Type	Type A(1ch)

### 5.3.2 USB OTG

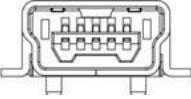
Type	Item	Specification
	USB Interface	USB 2.0
	Communication Method	Interrupt/Bulk/Isochronous
	Transfer Speed	480Mb/s
	Supporting OS	Windows 98SE/2000/XP/VISTA/7/10(32/64bit)
	Cable Length	1.5M(recommended to use M2I's Option Cable)
	Connect Type	MINI USB B, Female
	Connect Method	Connect through USB OTG

## 5.4 HDMI Specifications

Type	Item	Specification
 HDMI (FEMALE)	HDMI Version	HDMI v1.4a
	Supportive Resolutions	1280 x 720, 1024x768, 640x480 (Set in TDS S/W)
	Connector Type	HDMI Type A

## Chapter 6 Installation Warning

### 6.1 Location Select for Installation

- (1) This product should have at least 100mm space from other devices and be free from any mechanical hazards for safe use.
- (2) The installation should be done in  $-10\sim 50^{\circ}\text{C}$  and 10~80% environment.
- (3) If this product is installed in sealed space, cooling fan must be installed.
- (4) Do not make power cable and communication cable be neighboring. It can cause malfunction from noise.
- (5) An install location should be separated from power line and I/O cables which has a lot of noise. Also make the wiring length short as possible.

### 6.2 DIN RAIL Mounting and VESA bracket bonding

This product has DIN Rail (width 35mm) Hook for mounting.

#### 6.2.1 DIN RAIL

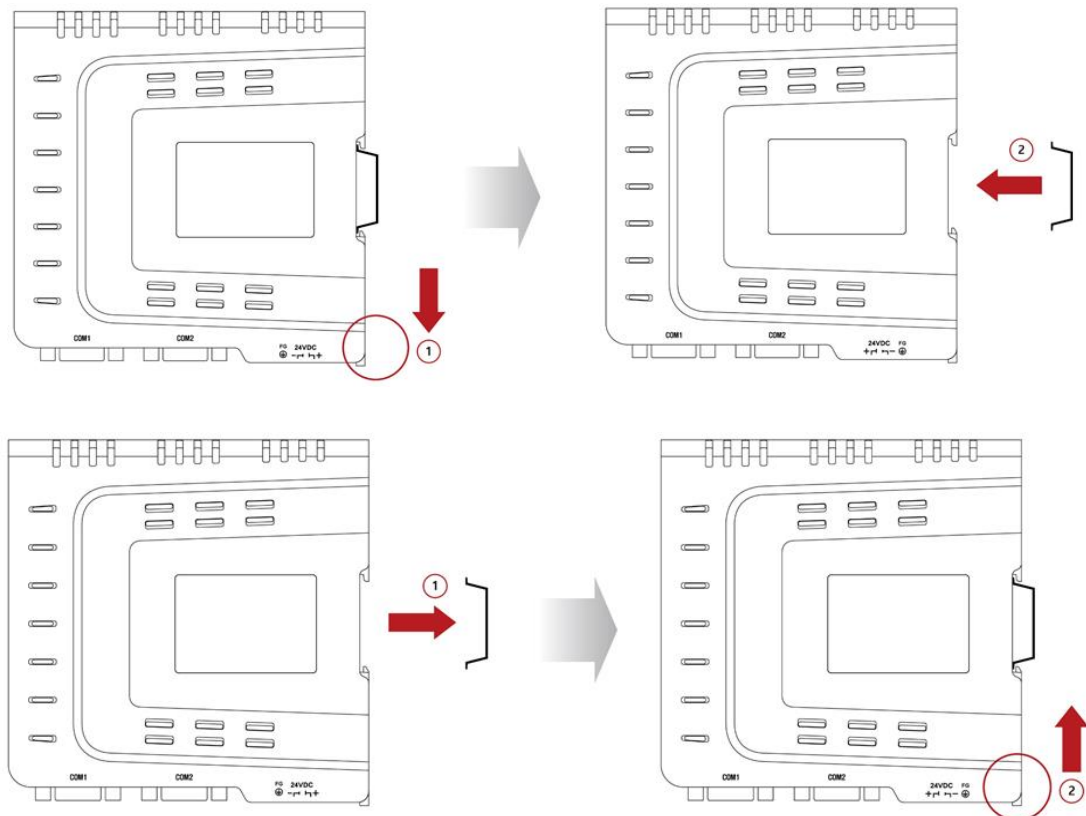

6.2.2 VESA bracket

(1) Standard of VESA bracket

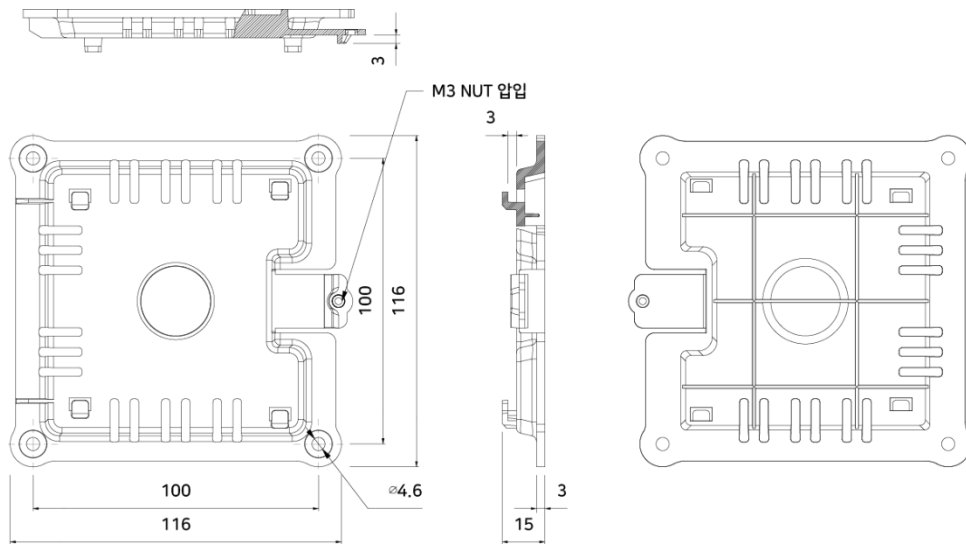

(2) When a VESA Bracket is attached, four fixing grooves should be put correctly.

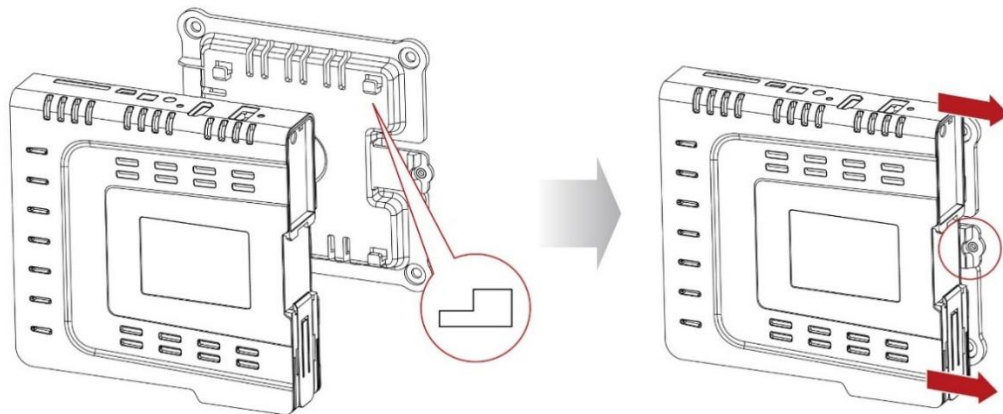

**Chapter 7 Wiring**  Warning

**7.1 Power Cable Wiring**

(1) The Power cable should have the following specification.

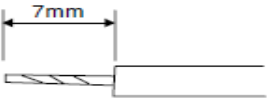
Power Cable Specification	0.75~2.5mm <sup>2</sup> (18~13AWG)
F.G Cable Specification	Over 2mm <sup>2</sup> (14AWG)
Conductor Type	Simple or Standard Wire
Bolt tightening force	≥ 0.4 N.m 
Conductor Length	
Temperature rating of the field installed conductors	65°C or under

(2) Pin Terminal Wiring  Warning

Caution: It is important to use Pin Terminal of power cable and contact terminals for maintaining a product's performance. Without using Pin Terminal which is not following this specification can cause electric shocks from abnormal cable connection. User should be well-informed about this Pin Terminal guide.

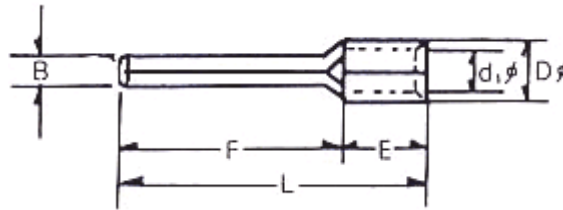

(mm)

B	L	F	E	D	d
1.8~2.0	22~18	12~14	5	3.3~3.8	2~2.5

(3) Wiring of power is as follows.  Warning

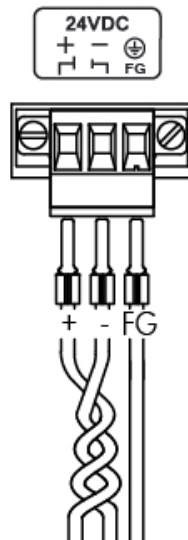

7.2 Ground Wiring  Warning

(1) The product has enough anti-noise measure, so except that there are many noises. Specially, the ground is not needed. When doing ground, please refer to the followings.

(2) The ground should be the exclusive ground. The ground should be type Class 3 ground. (ground resistor is less than 100Ω.)

(3) When you cannot do the exclusive ground, do common ground like figure B.

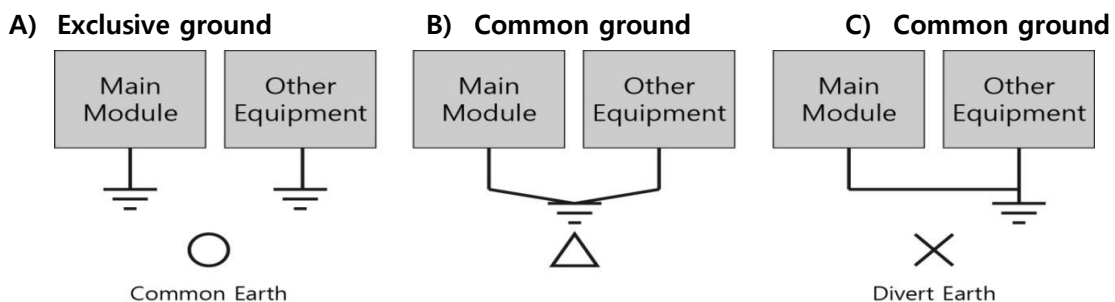

Fig. Grounding Example Diagram

(4) Use the cable more than 4mm<sup>2</sup>. Put the point of the ground near product and shorten Ground line.

### 7.3 Installation of Cable Clamp Warning

Caution: This cable clamps are installed for preventing disconnection and electronic sparks by loosen or breaking out of port and cable. Users should be well-informed about following guide.

(1) Put HDMI or USB cables through cable clamp as following image.

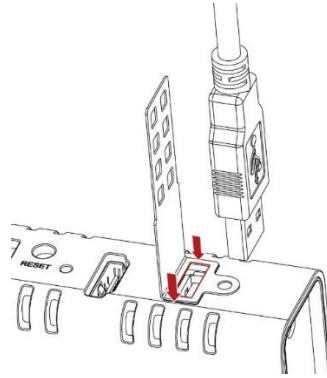

(2) Tighten the cable and clamp as following image, and use screw and bolt to fix the clamp to a product.

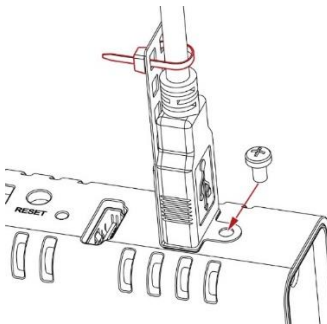

## Chapter 8 Maintenance Warning

### 8.1 Case Cleaning

Use soft cloth wet by detergent to wipe dirty surface of case out.

### 8.2 Periodic Check Points

Check the followings periodically for best condition of the device.

(1) Environment

- 1) Is the operating temperature within the allowable range (-10°C~50°C)?
- 2) Is the operating humidity within the allowable range (10%~80%RH)?
- 3) Is the Surrounding pollution no corrosive gas?

(2) Power

- 1) Is the input power in right range?

(3) Related Items

- 1) Check the touch pad there is no damage, scratch or pollution by eye.

### 8.3 Problems with the Device Warning

- (1) If there is a problem during operation, stop using it and contact the A/S department of M2I Corporation, which is indicated on the product label.
- (2) Only the authorized worker from M2I Corporation can check and repair problems related to malfunction of the machine.
- (3) If the problem cannot be solved at the installation site, the equipment can be collected and moved to M2I Corporation.
- (4) The manufacturer, M2I Corporation, is not responsible for damage or malfunction of the equipment caused by the use conditions of the user beyond the installation and use standards described in the manual.
- (5) When electromagnetic noise is over-radiated, Install the ferrite core to the body power and field power lines. Depending on the installation environment, noise from power lines and communication lines may be high.
- (6) In noisy places, recommended use of industrial display devices.
- (7) If the HDMI and USB devices do not operate normally due to noise, install ferrite cores on both ends of the cable to improve noise tolerance.

### 8.4 Setting System Recovery Mode

- (1) If the system fails to boot normally due to a problem during operation, the built-in recovery function can be used to maintain the factory default state. Please note that the built-in project will be deleted when using the recovery mode.
- (2) By the mode switch on side, you can adjust the setting switch. Keep the "Normal" state when booting normally. If the system is recovering, turn off the power and set it to "Factory Reset".
- (3) When the recovery is completed, the buzzer sounds, then turn off the power and reset to "Normal" state.

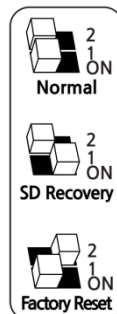

## Chapter 9 Products Label

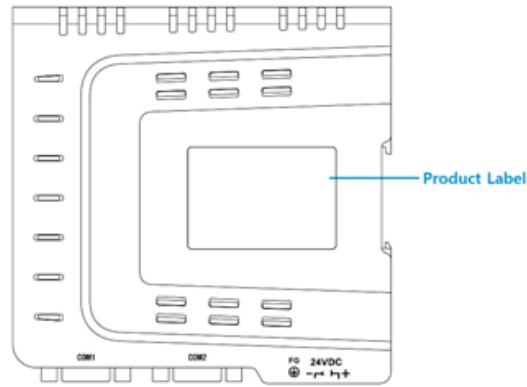

Manufacture (AS): M2I Corporation

11-35, Simin-daero 327beon-gil, Dongan-gu, Anyang-si, Gyeonggi-do 14055, Korea

Tel: 82-31-465-3366

Product Category: Industrial BOX-HMI

Model Name: TOPRP1000D

Operating Temp:  $-10\text{ }^{\circ}\text{C} \leq T_a \leq +50\text{ }^{\circ}\text{C}$

Power Specifications: 24Vdc, 10W or under

Inside Cell: MS920SE (Rechargeable lithium Battery/irreplaceable)

Copyright: M2I Corporation 2022.08

[www.m2i.co.kr](http://www.m2i.co.kr)

- Please read related contents in this manual when you use M2I product, and operate the product staying safe with appropriate handling.
- This manual should be stored in secured and appointed place so that it can be read in any needs.

### User Guide

This product has Relevant Assessments for business environment. If this product is used in home environment, there can be an interference.