

UDJET

USER GUIDE

Industrial Barcode Reader

MSR - B2MWA



M2I Corporation

Industrial Barcode Reader MSR-B2MWA, MSR-B2MWA-DONGLE

Hardware Manual

Thank you for purchasing the industrial Barcode reader of M2I corporation.

Please read this manual carefully to know installing, operating this equipment for safe use of this product.





Index

| | |
|---|----|
| Chapter 1. Safety Precautions..... | 4 |
| ■ Before using the product..... | 4 |
| ■ General Precautions..... | 4 |
| ■ Installation Precautions | 4 |
| ■ Disposal Precautions | 5 |
| Chapter 2. Overview | 5 |
| 2.1 Product Introduction | 5 |
| 2.2 Package Contents..... | 5 |
| Chapter 3. General Specifications | 6 |
| 3.1 Power Specifications | 6 |
| 3.2 Display and Memory Specifications..... | 6 |
| 3.3 functional Specifications..... | 6 |
| 3.4 Antenna information | 6 |
| 3.5 Environment Specifications..... | 6 |
| 3.6 Structure Specifications | 7 |
| Chapter 4. Part Names and General Specifications..... | 7 |
| 4.1 MSR-B2MWA and MSR-B2MWA-DONGLE | 7 |
| 4.2 Part Names and Specifications | 8 |
| Chapter 5. Interface | 9 |
| 5.1 USB..... | 9 |
| 5.2 RF Wireless Communication..... | 9 |
| 5.3 IrDA | 9 |
| Chapter 6. Installation | 10 |
| 6.1 Specifying Install Location..... | 10 |
| 6.2 Battery Charging | 10 |
| 6.3 Dongle Installation..... | 10 |
| 6.4 Infrared Communication (IrDA)..... | 10 |
| Chapter 7. Device operating and settings..... | 11 |
| 7.1 Base screen..... | 11 |
| 7.2 Learn the basics | 12 |
| Chapter 8. Maintenance | 16 |
| 8.1 Cleaning the Display and key pad | 16 |
| 8.2 Periodic inspection..... | 16 |
| 8.3 When a problem occurs with your device | 16 |
| 8.4 Self Diagnosis..... | 16 |
| Chapter 9. Products Label | 17 |
| 9.1. MSR-B2MWA..... | 17 |
| 9.2 MSR-B2MWA-DONGLE..... | 17 |











Chapter 1. Safety Precautions

■ Before using the product

To use the product safely and effectively, please read the contents of this manual thoroughly before use. Please keep to the safety precaution, for it is to prevent accidents and potential danger from occurring. Safety precaution is classified into 'Warning' and 'Caution' and their meanings are as follows. Also the indicated illustrations on the product and in the manual have the following meanings.

| | |
|--|---|
|  Warning | Violating the instruction may result in serious personal injury or death. |
|  Caution | Violating the instruction may result in slight personal injury or product damage. |
|  | Be cautious, for danger may be present. |
|  | Be cautious, for there is a possibility of an electric shock. |





■ General Precautions Caution

-  Do not press the screen with a hard or sharp object (awl, screwdriver, pen) with too strong a force. It may cause malfunction of touch due to damage of the front sheet.
-  Do not use or store in an environment with high vibration.
-  Do not allow foreign objects such as water, liquids, or metal powders to enter the product. This may cause breakage or electric shock.
-  Do not allow foreign objects such as water, liquids, or metal powders to enter into the front(screen) protective sheet. The screen may be invisible or may cause a malfunction of the touch.
-  Use the radio or mobile phone at least 30cm away from the main unit.
-  Two or fewer bright spots may appear on the display, and certain areas may appear brighter, but this is not a defect in display characteristics.
-  Do not store or operate in direct sunlight. Direct sunlight can change the properties of the display.
-  Do not touch the adapter or power cord with wet hands. There is a risk of electric shock.
-  Do not charge or use the battery in explosive environments with flammable liquids, gases, or dust.
-  When storing the product for a long time without using the product, store it in a dry environment without direct sunlight.

Record/store your data separately. When the product is repaired, the main contents of the device may be deleted.

■ Installation Precautions Caution

Do not install the location which exceeds allowed temperature. Product can be damaged or shorten the life. Especially Install environment as below should be avoided.

-  Do not Install product to the place which the ambient temperature is out of limits, from 10°C to 45°C or on the surface of control board which high pressure equipment is installed.
-  Do not install to the place where strong shock or vibration continuously have impacted on product.
-  When leaving for a long time without using the product, charge it and store it at room temperature.
-  Indoor use.
-  Altitude up to 2000m.

■ Disposal Precautions Caution

When you dispose of product and battery, please treat it as industrial waste. It can create poisonous substances or explosion.

Chapter 2. Overview

2.1 Product Introduction

This industrial Barcode reader is an industrial control device required in industrial field.



It is a device that is used for basic purposes to communicate with other devices (PC, HMI, etc.) using high durability and wired / wireless communication.

This unit is battery operated and highly portable for universal use.

2.2 Package Contents

The components of the product are as follows.

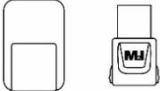
Before using the product, please check that all of the following components are included.

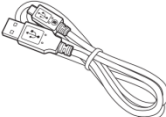
| Item | Figure | Quantity |
|--|--|----------|
| Product (MSR-B2MWA) |  | 1 |
| RF Wireless Dongle (MSR-B2MWA-DONGLE) |  | 1 |
| Manual |  | 1 |
| Strap |  | 1 |
| USB charge cable (Charge & Data combined) |  | 1 |

Chapter 3. General Specifications

3.1 Power Specifications

| | | | |
|---------------------------|-------------------|-------------------------------------|------------------|
| Rated Input Voltage (Vin) | | DC 5.0V | |
| Battery Voltage Range | | DC 3.20V ~ 4.20V (Standard : 3.70V) | |
| Internal Battery Pack | Cell Type | Lithium - ion (1S1P) | |
| | Consumption | 3.0W less | |
| | Operating time | 13 Hours (*Low Voltage Warning) | |
| | Charging time | 5.5 Hours (*Full Charge) | |
| | Charging Capacity | 1800mAh(Minimum) | 1800mAh(Nominal) |

* Operating time and charging time are based on 25 °C ambient temperature and may vary depending on the ambient temperature.

** The operating time may vary depending on the usage pattern.

3.2 Display and Memory Specifications

| | |
|-----------------|-----------|
| Type | 1.3" OLED |
| Resolution(dot) | 128 x 64 |
| Internal Memory | 512KB |

3.3 functional Specifications

| | | |
|-----------------|-------------------------------|--|
| Barcode Scanner | Sensor resolution & Scan type | 640(H) x 400(V), 1D/2D CMOS Barcode |
| | Data storage internal memory | 32,768 Code (*GTIN-08 / EAN-8) 24,966 Code (*GTIN-13 / EAN-13) 23,831 Code (*GTIN-14 / ITF-14) |
| | Light Source | Aiming 610nm LED, Illumination 660nm LED |
| Alarm | | Buzzer and LED light |
| LED indication | | Power ON(Green), Charging(Red), Status Indication |
| Action button | | Power, Scan, Up, Down, Send, Erase |

* The storage capacity may change depending on the manufacturer.

3.4 Antenna information

| | |
|--------------------|-------------------|
| Antenna Model Name | ANT3216LL00R2400A |
| Antenna Type | Internal Antenna |
| Manufacturer | YAGEO |

3.5 Environment Specifications

| | |
|------------------------------|---|
| Operation Temperature (°C) | Main body : +10 ~ +45 / RF wireless dongle : -10 ~ +50 |
| Storage Temperature (°C) | -20 ~ +60 |
| Operation Humidity (%RH) | 0 ~ 90 (No dew) |
| Atmosphere | No corrosive gas |
| Vibration Endurance | Amplitude: 10≤F < 25Hz(2G) X,Y,Z each direction(for 30 minutes) |
| Noise Immunity | 1000Vp-p(Pulse width 1μs) |
| Static Electricity Discharge | Connective discharge from EN61000-4-2: ±4kV |

| | |
|----------------------------|--|
| BARCODE LED Classification | Exempt Risk Group LED product per IEC/EN 62471 |
| Protection Classification | Product body IP67 |

3.6 Structure Specifications

| | | |
|----------------|----------------------------------|------------------|
| Weight(g) | MSR-B2MWA | MSR-B2MWA-DONGLE |
| | 180 | 3 |
| Cooling System | Natural air circulation | |
| Case Material | PC(Flame Retardant) and Urethane | |

Chapter 4. Part Names and General Specifications

4.1 MSR-B2MWA and MSR-B2MWA-DONGLE

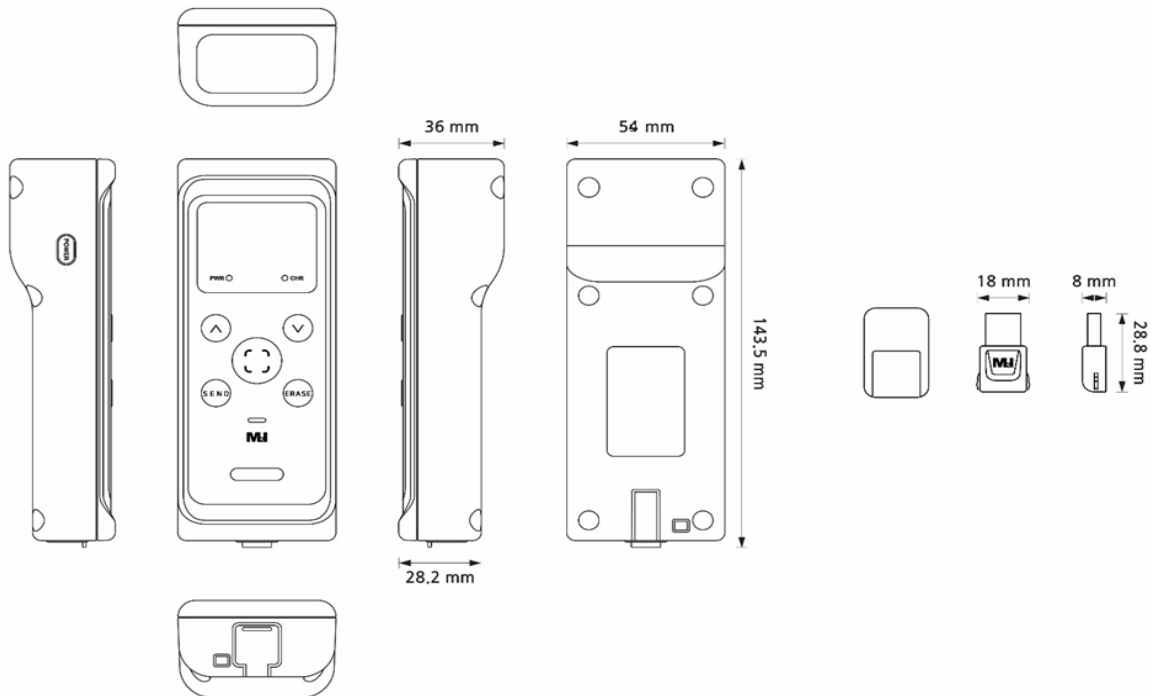

| Item | W (mm) | D (mm) | H (mm) |
|------------------|--------|----------|--------------|
| MSR-B2MWA | 54 mm | 143.5 mm | 36 / 28.2 mm |
| MSR-B2MWA-DONGLE | 18 mm | 28.8 mm | 8mm |

4.2 Part Names and Specifications

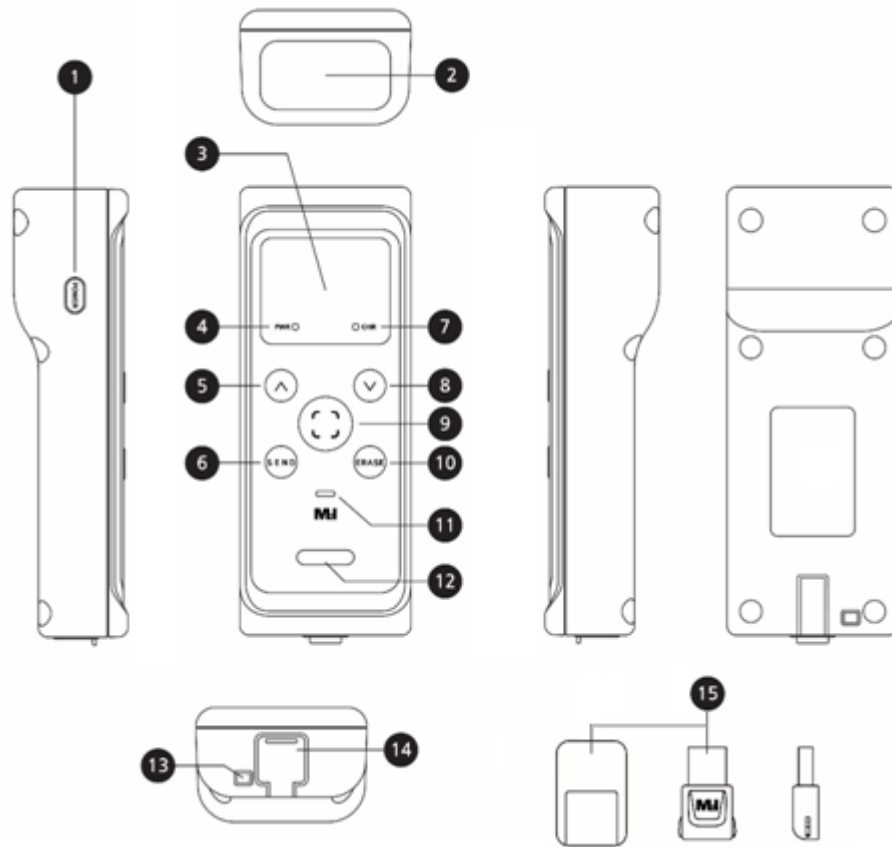

| No. | Item | Description |
|-----|-------------------------|---|
| ① | Power Switch | Power ON, OFF Switch |
| ② | Scanner window and IrDA | barcode scanner window and IrDA |
| ③ | OLED | 1.3" OLED Display |
| ④ | Power LED | Display the System Power State |
| ⑤ | UP Switch | UP Switch |
| ⑥ | SEND Switch | SEND Switch |
| ⑦ | Charge status indicator | Red: Charging, OFF: Charged |
| ⑧ | DOWN Switch | DOWN Switch |
| ⑨ | SCAN Switch | SCAN Switch |
| ⑩ | ERASE Switch | ERASE Switch |
| ⑪ | Buzzer hall | Buzzer sound |
| ⑫ | Status indicator | Green: scan success, Yellow: data transfer and deletion |
| ⑬ | Strap fixing hole | Strap Attached Hole |
| ⑭ | Back cover | USB connector cover |
| ⑮ | USB Dongle | USB Dongle and Case for RF Wireless Communication * Model Name: MSR-B2MWA-DONGLE |

Chapter 5. Interface

In order for the main unit to communicate with an external device, it is necessary to connect the two devices by referring to the following.

5.1 USB

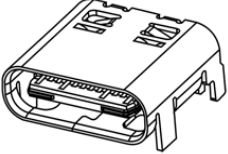
| Form | Item | Description |
|---|----------------------|---|
|  | USB Interface | EHCI/OHCI Specification Version 1.0, USB 1.1 compatible |
| | Communication Method | Control/Bulk |
| | Transfer Speed | Max. 12Mb/s |
| | Connector Type | Type C |

5.2 RF Wireless Communication

(Dedicated wireless dongle required. * Model Name: MSR-B2MWA-DONGLE)

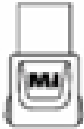
| Form | Item | Description |
|---|-----------------|---|
|  | RF Interface | IEEE 802.15.4 |
| | Transfer Speed | Max. 2Mb/s |
| | Frequency Range | 2322 ~ 2527 MHz |
| | Supporting OS | Windows 98SE/2000/XP/VISTA/7/10(32/64bit) |
| | Connect | Wireless dongle |

5.3 IrDA

| Form | Item | Description |
|---|---------------------|---|
|  | Connection distance | 1.0 M (May vary depending on the use environment) |
| | Transfer Speed | 115.2k bit/s |
| | Peak wavelength | 900 nm |
| | Connection device | (M2I) TOPRD□□30□ Dedicated Communication Port |

Chapter 6. Installation Warning

6.1 Specifying Install Location

- 1) Where the operation of the body is guaranteed.
- 2) Easy connection and disconnection of main body and charging cable.
- 3) Where the body and dongle are open.
- 4) Out of direct sunlight.

6.2 Battery Charging

Connect the bottom of the terminal to the USB cable (USB-C Type).

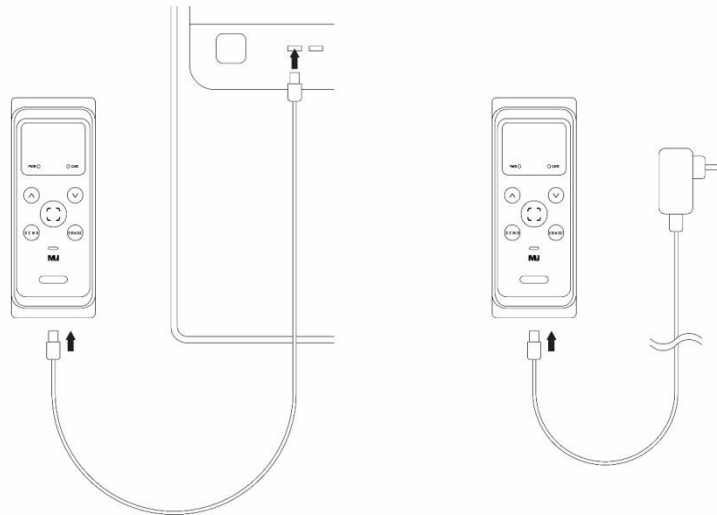

6.3 Dongle Installation

A separate wireless dongle is provided for RF wireless communication between the main unit and the device. There is no need to install a separate driver using the Windows built-in driver.

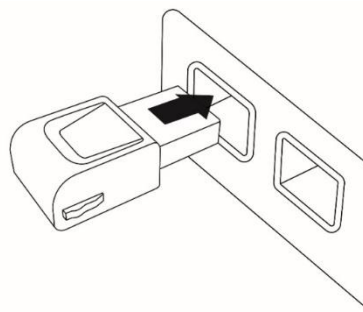

6.4 Infrared Communication (IrDA)

This device is for infrared communication with M2I Corporation TOPRD□□30□.

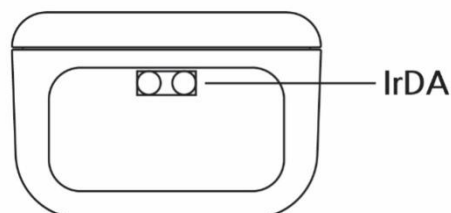



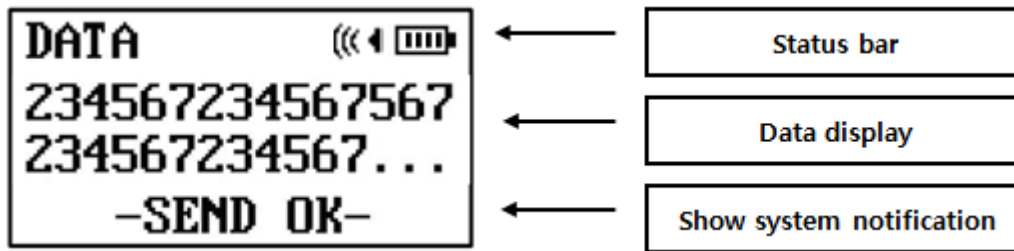

Chapter 7. Device operating and settings.

7.1 Base screen



7.1.1 The status bar provides the device's mode status, communication mode and battery status.

| Icon | Description |
|---|--|
| SCAN | Successful reading of the data code is indicated with the data value. |
| DATA | Displayed when managing internal memory data. |
|  | Indicates that the device is connected in IrDA communication mode. |
|  | Indicates that the device is connected in USB communication mode. |
|  | Indicates that the device is connected in RF communication mode. |
|  | Indicates the internal battery level. If the battery is low, a low voltage warning message is generated and the power is automatically turned off. |

7.1.2 Show system notifications displays a notification window from which you can choose to manage and control your device.

| Text | Description |
|-------------|--|
| READY | Indicates that the device is operating normally. |
| SCAN OK | Indicates that reading the data code was successful. |
| SEND? | Confirm that you want to send the selected data. When pressed again, it is sent. |
| SEND ALL? | Confirm that you want to transfer all data stored on the device. When pressed again, it is sent. |
| SEND OK | Indicates that the transfer of data stored on the device was successful. |
| ERASED? | Confirm that you want to delete the selected data. Press again to delete. |
| ERASED ALL? | Confirm that you want to delete all data stored on the device. Press again to delete. |
| EMPTY | Indicates that data stored on the device does not exist. |
| TOTAL [] | Displays the number of data currently stored in the internal memory. |

7.2 Learn the basics

7.2.1 Power On and Off

Press the "POWER" button located on the side of the device to turn on the power. Press again to turn off the power. When left for 10 minutes to optimize the usage time, the power is automatically turned off.

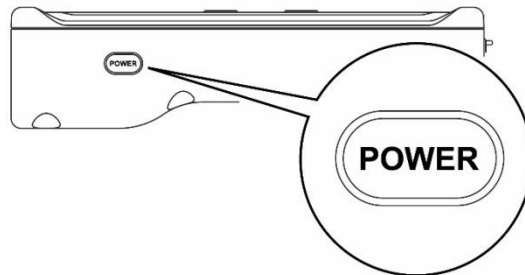

7.2.2 Scanning Barcodes

Press the "SCAN" button to activate the scan mode. If the barcode is successfully read, the scan mode will automatically end with a buzzer sound, and the read data value will be displayed on the screen. Activated while the button is pressed.

The scanned data is transmitted in real time and stored in internal memory when the device is connected in communication mode. If not connected, data will only be stored in internal memory.

| Data | Communication mode Connection Status | Communication mode not connected |
|----------------------|--------------------------------------|----------------------------------|
| Internal memory | Save | Save |
| Online Data transfer | Enable | Disable |

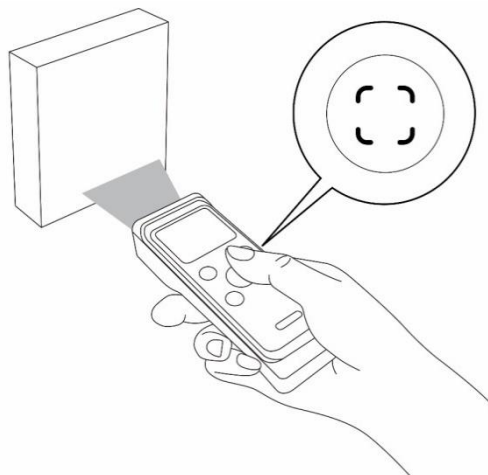

If the scan is successful, the save number and read data code are displayed and "Scan OK" is displayed.

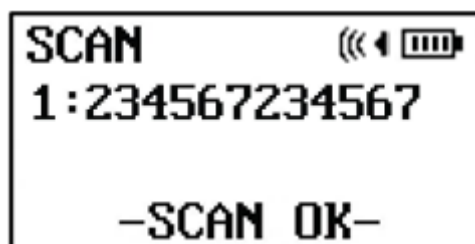

⊘ Do not point the scanner window at people or animals when scanning barcodes. May damage the retina and reduce vision.

Minimum resolution and optimum distance for scanning are as follows.  **Caution**

| Symbology | Resolution | Near | Far |
|-------------|------------|--------|---------|
| Code 39 | 0.127 mm | 5.1 cm | 16.2 cm |
| Code 39 | 0.508 mm | 5.0 cm | 49.5 cm |
| Code 128 | 0.127 mm | 6.3 cm | 12.7 cm |
| PDF417 | 0.167 mm | 6.3 cm | 16.0 cm |
| PDF417 | 0.254 mm | 4.5 cm | 22.8 cm |
| 100% UPC | 0.330 mm | 5.0 cm | 31.7 cm |
| Data Matrix | 0.508 mm | 3.8 cm | 34.3 cm |
| QR Code | 0.508 mm | 3.8 cm | 27.9 cm |

7.2.3 Checking Stored Data

Press the "UP" / "DOWN" button to check the saved data. The total number of stored data, the order of saving and the corresponding data value are displayed.

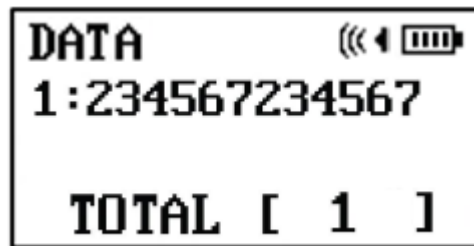

7.2.4 Transferring Data

You can immediately send data to the connected device by pressing the "SEND" button.

- 1) You can select and transfer the data saved in the internal menu with the "UP" and "DOWN" buttons.
- 2) When "SEND" is pressed, "SEND?" A confirmation window will appear. Press send again.
- 3) Press the "SEND" button for more than 3 seconds to transfer the data stored in the internal memory at once.
- 4) If a communication failure occurs during transmission, only data that has been successfully transmitted until the failure occurs.

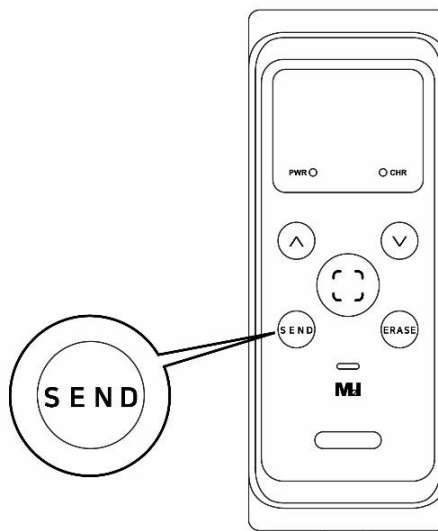

"Send OK" is displayed upon successful transmission.



Data transmission supports 3 modes, and connection priority is as follows. The connection priority cannot be changed arbitrarily.

1st: Infrared Communication (IrDA)



2nd: USB cable connection

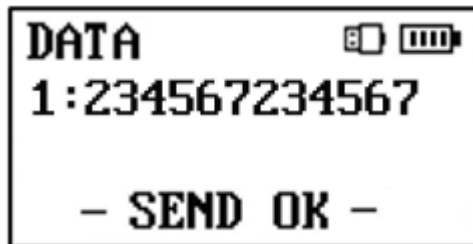

3rd: RF Wireless Communication (with Dongle)

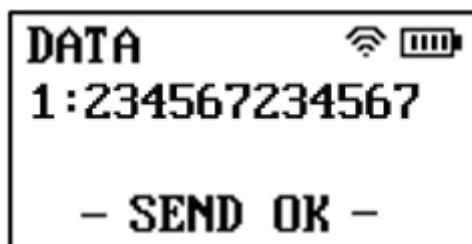

*

7.2.5 Deleting data

You can delete the saved data by pressing the "ERASE" button.

- 1) You can select and delete the data saved internally with "UP" and "DOWN" button.
- 2) When pressed, "ERASE?" A confirmation window will appear. Press again to delete.
- 3) To delete the saved data at once, press the "ERASE" button for 3 seconds or longer, press the "ERASE?" Press again to confirm.

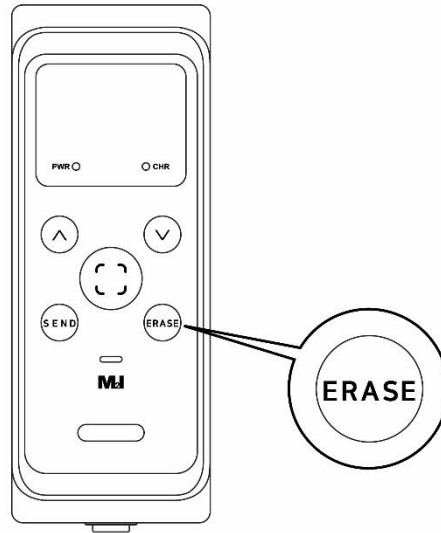

Total data of remaining data is displayed when deleting data.

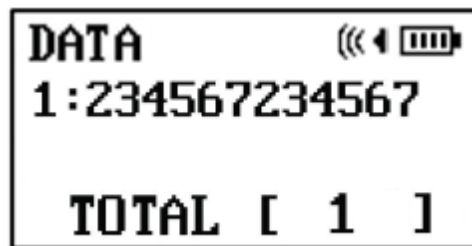

Chapter 8. Maintenance Warning

8.1 Cleaning the Display and key pad

When the surface or frame of the display, key pad or shock-absorbing cushion become dirty, spray the cleaning solution onto a soft cloth and wipe the device. Do not spray the cleaning solution directly onto the device

8.2 Periodic inspection

For the best condition of this product, periodic inspections are required.

1) Environment

- a. Are you operating within the specified temperature range (10 °C to 45 °C)?
- b. Are you operating within the specified humidity range (10 % to 90 % RH)?
- c. Is there any corrosive gas around?

2) Power

Is the input voltage range (-15% ~ + 10%) correct?

3) Related Topics

- a. Please check the display replacement time with your eyes.
- b. Check your eyes for scratches and dirt.

8.3 When a problem occurs with your device Warning

- 1) If any problem occurs during operation, stop using it and please call M2I Corporation A/S department.
- 2) Only authorized workers authorized by M2I Corporation can inspect and repair problems related to malfunction of this equipment.
- 3) If the problem cannot be solved at the installation site, the equipment can be collected and moved to M2I Corporation.
- 4) The manufacturer, M2I Corporation, is not responsible for damage or malfunction of the equipment caused by the use conditions of the user beyond the installation and use standards described in the manual.
- 5) The longer the battery life, the lower the performance, resulting in less battery life. If the operation time of the device is reduced too much, please contact A/S department of M2I Corporation.
- 6) If you press the power button while pressing the "UP" and "DOWN" keys at the same time, the product enters the manufacturer management mode and nothing appears on the screen.

8.4 Self Diagnosis

The self-diagnosis function is activated at boot time to check the functional status of the device.

- 1) If there is a problem with the RF radio, the buzzer sounds three times and the message "Wireless Fail" is displayed. However, you can transfer using IrDA and USB cables.
- 2) If there is a problem in the internal memory, the buzzer will sound three times and a "Memory Fail" message will be displayed. Data can not be saved even by SCAN. Please contact A / S department of M2I Corporation.
- 3) If a problem occurs with the display, the buzzer sounds three times. Please contact A/S department of M2I Corporation.

Chapter 9. Products Label

9.1. MSR-B2MWA



Manufacture (AS): M2I Corporation

11-35, Simin-daero 327beon-gil, Dongan-gu, Anyang-si, Gyeonggi-do, 14055 , Republic of Korea

Device type: Industrial Barcode reader

Model: MSR-B2MWA

Operating Temperature: $10\text{ }^{\circ}\text{C} \leq T_a \leq +45\text{ }^{\circ}\text{C}$

Power Specification: 3.2 ~ 4.2Vdc, 3.0W or less, Lithium-ion battery

KC Approval Number:

Product number:

9.2 MSR-B2MWA-DONGLE



Manufacture (AS): M2I Corporation

11-35, Simin-daero 327beon-gil, Dongan-gu, Anyang-si, Gyeonggi-do, 14055 , Republic of Korea

Device type: Industrial Barcode reader

Model: MSR-B2MWA-DONGLE

Operating Temperature: $-10\text{ }^{\circ}\text{C} \leq T_a \leq +50\text{ }^{\circ}\text{C}$

Power Specification: 5.0Vdc, 1.0W less

KC Approval Number:

Product number:

Copyright: M2I Corporation 2020.12

www.m2i.co.kr

- When using M2I equipment, thoroughly read this datasheet and associated manuals introduced in this datasheet, also pay careful attention to safety and handle the module properly.
- Store this datasheet in a safe place so that you can take it out read it whenever necessary.

The product is an industrial equipment used in manufacturing or production processes and is suitable according to Article 58-2 of the Radio Wave Act.