



**M2I Corporation**

**Industrial HMI Touch Panel**

**TOPRW Series**

**Hardware Manual**

---

Thank you for purchasing the industrial HMI touch panel series of M2I corporation.

Please read this manual carefully to know installing, wiring, operating this equipment for safe use of this product.





## Contact

Contact .....	2
Chapter 1 Safety Precautions.....	3
Chapter 1 Consignes de sécurité.....	5
Chapter 2 Overview .....	7
2.1 Introduction of Products.....	7
2.2 Components.....	7
2.3 Explanation of Model Name .....	7
Chapter 3 General Specifications .....	8
3.1 Power Specifications .....	8
3.2 Memory Specifications.....	8
3.3 Display Specifications .....	8
3.4 Touch Specifications .....	8
3.5 Environment Specifications.....	8
3.6 Structure Specifications .....	9
Chapter 4 Part Names and General Specifications.....	9
4.1 TOPRW0500WD .....	9
4.2 TOPRW07□□WD / TOPRW0700WD NE.....	10
4.3 TOPRW10□□WD .....	12
Chapter 5 External Device Interface .....	14
5.1 Serial Communication Specifications .....	14
5.2 Ethernet Communication Specifications.....	15
5.3 USB Communication Specifications.....	16
Chapter 6 Installation .....	16
6.1 Installation Requirement.....	16
6.2 Installation Procedure.....	17
Chapter 7 Wiring .....	18
7.1 Power Cable Wiring.....	18
Chapter 8 Maintenance .....	19
8.1 Cleaning the Display.....	19
8.2 Periodic Check Points.....	19
8.3 Problems with the Device .....	19
8.4 Setting System Recovery Mode.....	20
Chapter 9 Products Label / Warning Label.....	20
9.1 TOPRW0500WD .....	20
9.2 TOPRW07□□WD / TOPRW0700WD NE / TOPRW10□□WD.....	21

## Chapter 1 Safety Precautions







### ■ Before using the product

To use the product safely and effectively, please read the contents of this manual thoroughly before use. Please keep to the safety precaution, for it is to prevent accidents and potential danger from occurring. Safety precaution is classified into 'Warning' and 'Caution' and their meanings are as follows. Also the indicated illustrations on the product and in the manual have the following meanings.





 <b>Warning</b>	Violating the instruction may result in serious personal injury or death.
 <b>Caution</b>	Violating the instruction may result in slight personal injury or product damage.
	Be cautious, for danger may be present.
	Be cautious, for there is a possibility of an electric shock.

### ■ General Precautions Caution

Do not install the location which exceeds allowed temperature. Product can be damaged or shorten the life. Especially Install environment as below should be avoided

-  Do not press the screen with a hard or sharp object (awl, screwdriver, pen) with too strong a force. It may cause malfunction of touch due to damage of the front sheet.
-  Do not use or store in an environment with high vibration.
-  Do not allow foreign objects such as water, liquids, or metal powders to enter the product. This may cause breakage or electric shock.
-  Do not allow foreign objects such as water, liquids, or metal powders to enter into the front(screen) protective sheet. The screen may be invisible or may cause a malfunction of the touch.
-  Use the radio or mobile phone at least 30 cm away from the main unit.
-  Two or fewer bright spots may appear on the LCD screen, and certain areas may appear brighter, but this is not a defect in LCD characteristics.
-  Do not store or operate in direct sunlight. Direct sunlight can change the properties of the LCD.

### ■ Design Precautions Warning

-  Install protection circuit on the outside of Products to protect the entire control system when external power supply or Products have problems.
-  As the malfunction & incorrect result of Products could damage the stability of the entire systems and human body, you must install damage preventing interlock circuit such as emergency stop, Protective circuits, positioning upper and lower limit switch and interlock for forward / reverse operation.
-  When computer or other controllers communicate and exchange data with products or change operation mode of products, set up protective sequence program in PC or Controller for protecting system from communication error.
-  The output signal or communication lines should be separated from the power line or high tension wire. They should be installed 100 mm (3.94 Inch) or more from each other.

■ Wiring Precautions **⚠ Warning**

- ❗ Be sure the wiring is done correctly by checking the product’s rated voltage and the terminal layout. Incorrect wiring could result in fire, damage or malfunctions.
  - ❗ Tighten the terminal screw with the specified torque. If the screws of terminal are loose, it could result in short circuit, fire, malfunctions. FG Terminal must be used a dedicated ground. Not doing so could result in malfunctions.
  - ❗ a. Grounding should be the Class 3 grounding. The cable for grounding should be more than 2 mm<sup>2</sup>.
  - ❗ b. grounding point be closed to the products and make short the distance to the ground cable if possible.
- Please see below.

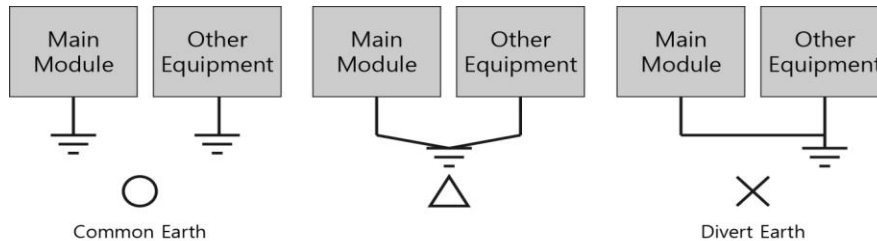

Fig. Grounding Example Diagram

■ Installation Precautions **⚠ Caution**

Do not install the location which exceeds allowed temperature. Product can be damaged or shorten the life. Especially Install environment as below should be avoided.

- ⊘ Do not Install product to the place which the ambient temperature is out of limits, from -10 ~ 50 °C or on the surface of control board which high pressure equipment is installed.
- ⊘ Do not install to the place where strong shock or vibration continuously have impacted on product.
- ⊘ Do not store or operate the product under direct sunlight. This may damage to the quality of LCD.
- ⊘ Use the product indoors only.
- ⊘ Use the product under 2000 m altitude.

■ Disposal Precautions **⚠ Caution**

When you dispose of product and battery, please treat it as industrial waste. It can create poisonous substances or explosion.

■ Cell Type Battery Specifications and Exchange **⚠ Caution**

Mounted on mainboard Model MS920SE Battery is not replaced by the user. If the battery has run out of service, please contact our Customer Support Center for replacement and inspection.

Item	Content
Battery Voltage	DC 3 V
Battery Model	MS920SE (lithium / Rechargeable )
Battery lifetime	Permanent (In case of ambient temperature 25 °C)





\* Depending on the model specifications are subject to change.

■ All field-wiring connections to this unit shall be from Limited Voltage/Limited Current, below 24 Vdc isolated secondary source with an output fuse, or Class 2.

## Chapter 1 Consignes de sécurité

### ■ Avant d'utiliser le produit

Pour utiliser le produit en toute sécurité et de manière efficace, veuillez lire attentivement le contenu de ce manuel avant toute utilisation. Veuillez respecter les consignes de sécurité afin de prévenir les accidents et tout danger potentiel. Les consignes de sécurité sont classées en 'Avertissement' et 'Attention', dont les significations sont les suivantes. De plus, les illustrations indiquées sur le produit et dans ce manuel ont les significations suivantes.

 <b>Warning</b>	Le non-respect de cette consigne peut entraîner des blessures graves voire mortelles.
 <b>Caution</b>	Le non-respect de cette consigne peut entraîner des blessures légères ou des dommages matériels.
	Soyez prudent, un danger potentiel peut être présent.
	Soyez prudent, un risque de choc électrique est possible.

### ■ Précautions générales Caution

 D Ne pas appuyer sur l'écran avec un objet dur ou pointu (poinçon, tournevis, stylo) avec une force excessive.

It may cause malfunction of touch due to damage of the front sheet.

 Ne pas utiliser ou stocker dans un environnement à forte vibration.

 Ne laissez pas entrer d'objets étrangers tels que de l'eau, des liquides ou des poudres métalliques dans le produit. Cela pourrait entraîner des cassures ou des chocs électriques.

 Utilisez le radio ou le téléphone mobile à au moins 30 cm de l'unité principale.

 lumineuses, mais cela ne constitue pas un défaut des caractéristiques de l'écran LCD.

 Ne pas stocker ou faire fonctionner l'appareil en plein soleil. La lumière directe du soleil peut modifier les propriétés de l'écranLCD.

AVERTISSEMENT – NE PAS CONNECTER OU DÉCONNECTER LORSQUE L'ÉQUIPEMENT EST SOUS TENSION. Ou équivalent.

### ■ Précautions de conception Warning

installez un circuit de protection à l'extérieur des produits afin de protéger l'ensemble du système de contrôle en cas de problème avec l'alimentation externe ou les produits.

 Comme un dysfonctionnement ou un résultat incorrect des produits pourrait nuire à la stabilité de l'ensemble du système et à la sécurité des personnes, vous devez installer un circuit d'interverrouillage préventif, tel qu'un arrêt d'urgence, des circuits de protection, des fins de course supérieur et inférieur, et un interverrouillage pour les opérations avant/arrière.

 Lorsque l'ordinateur ou d'autres contrôleurs communiquent et échangent des données avec les produits ou modifient le mode de fonctionnement des produits, configurez un programme de séquence de protection dans le PC ou le contrôleur afin de protéger le système contre les erreurs de communication.

 Les lignes de signaux d'entrée/sortie ou de communication doivent être séparées de la ligne d'alimentation ou des câbles haute tension. Elles doivent être installées à au moins 100 mm (3,94 pouces) les unes des autres.

## ■ Précautions de câblage Warning

- ❗ Assurez-vous que le câblage est effectué correctement en vérifiant la tension nominale du produit et la disposition des bornes. Un câblage incorrect pourrait provoquer un incendie, des dommages ou des dysfonctionnements.
- ❗ Serrez les vis des bornes avec le couple spécifié. Si les vis des bornes sont desserrées, cela pourrait entraîner un court-circuit, un incendie ou des dysfonctionnements.
- ❗ La borne FG doit être utilisée comme une mise à la terre dédiée. Ne pas le faire pourrait entraîner des dysfonctionnements.
- ❗ a. La mise à la terre doit être de classe 3. Le câble de mise à la terre doit avoir une section d'au moins 2 mm<sup>2</sup>.
- ❗ b. Le point de mise à la terre doit être proche des produits et réduire autant que possible la distance jusqu'au câble de mise à la terre.

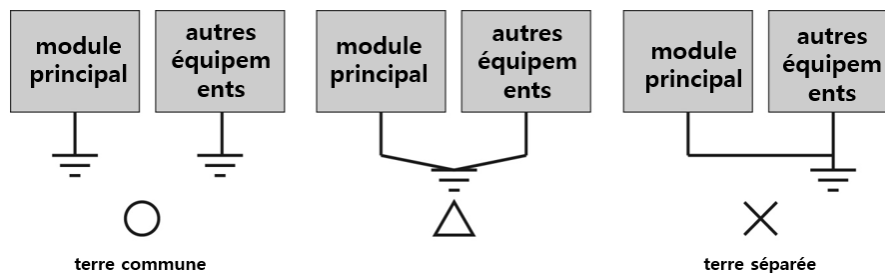

fig. : exemple de schéma de mise à la terre

## ■ Précautions d'installation Caution

- ⊘ N'installez pas l'équipement dans un endroit où la température dépasse la limite autorisée. Le produit peut être endommagé ou voir sa durée de vie réduite. En particulier, l'environnement d'installation suivant doit être évité.
- ⊘ N'installez pas le produit dans un endroit où la température ambiante dépasse les limites autorisées, soit de -10 à 50°C, ou sur une surface de panneau de contrôle où des équipements à haute pression sont installés.
- ⊘ N'installez pas le produit dans un endroit où des chocs ou des vibrations fortes et continues affectent l'équipement.
- ⊘ Utilisez le produit à une altitude inférieure à 2000 m.
- ⊘ Utilisation en intérieur uniquement.

## ■ Précautions de mise au rebut Caution

Lorsque vous vous débarrassez du produit et de la batterie, veuillez les traiter comme des déchets industriels. Cela peut créer des substances toxiques ou provoquer des explosions.

## ■ Spécifications de la batterie Caution

- ⊘ Une batterie interne MS920SE sur la carte mère ne peut être remplacée que dans un endroit non explosif. Veuillez vérifier les informations ci-dessous pour effectuer le remplacement correctement.

Élément	Informations
Tension et capacité	DC 3.0 V
Nom du modèle et fabricant	MS920SE (Lithium / Rechargeable )
Durée de vie de la batterie	Permanent (en cas de température ambiante de 25 °C)

\* Les spécifications sont susceptibles de changer en fonction du modèle.

■ Toutes les connexions de câblage sur le terrain à cette unité doivent provenir d'une source secondaire isolée à **\*\*tension limitée / courant limité\*\***, inférieure à 20 ~ 28 VDC avec un fusible de sortie, ou de circuits secondaires de Classe 2.

## Chapter 2 Overview







### 2.1 Introduction of Products

This industrial HMI touch panel is an industrial control device required in industrial field. It is a device based on RS-232C and RS-422 / 485, Ethernet used for the basic purpose of communication with another device (PLC).

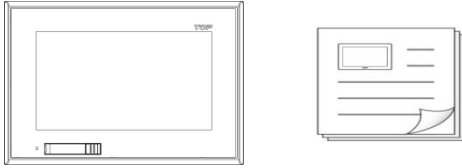
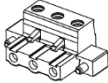
### 2.2 Components

The components of the product are as follows.

Before using the product, please check that all of the following components are included.

Components	Figure	Quantity
Process Module and Manual		1
Clamp		1
Power Connector		4
Accessories (Sold separate)	 USB Memory  USB Cable  SD Card  Protection Sheet	User Options

### 2.3 Explanation of Model Name

TOPRW	□□	□□	□	□	Ex		□□
Series	Screen	Options	Resolution	Power	Explosion Proof	Blank	Etc
	05: 5.0" 07: 7.0" 10: 10.0"	00: Basic 10: Premium □1: without SD Card Port	W: WQVGA(480*272), WVGA(800*480) WSVGA(1024x600)	D: DC	-Ex: Explosion Proof NE: Non-Ethernet Blank: Normal		□□: Not affective to explosion proof, it can be shown as letters or numbers

## Chapter 3 General Specifications

### 3.1 Power Specifications

Input Voltage	DC 24 V, Class 2	
Input Voltage Range	DC 20 ~ 28 V, Class 2	
Power Consumption	TOPRW0500WD	12 W
	TOPRW07□□WD	
	TOPRW0700WD NE	
	TOPRW10□□WD	15 W
Voltage endurance	DC 24 V, within 10 ms	
Insulation Resistance	500 V DC, 10 MΩ	

### 3.2 Memory Specifications

Screen Memory	128 MB
Backup Memory	512 KB: System buffer (10 K Word), Including Alarm / Log / Recipe
Backup Period	Permanent
Real Time Clock	Built in (by Battery)

### 3.3 Display Specifications

Color	16 M Colors
Brightness	10 Level (by software)
Backlight	LED
Backlight Lifetime	50,000 hours
Display Font	MS Windows Vector font, Free Resolution Font
Front LED Indicate	Built in

### 3.4 Touch Specifications

Touch Type	Built-in, Analog resistive touch sensor
------------	---

### 3.5 Environment Specifications

Operation Temperature (°C)	-10 ~ +50
Storage Temperature (°C)	-20 ~ +60
Operation Humidity (%RH)	0 ~ 90 (No dew)
Atmosphere	No corrosive gas
Vibration Endurance	Amplitude: $10 \leq F < 25$ Hz (2G) X, Y, Z each direction(for 30 minutes)
Noise Immunity	1000 Vp-p (Pulse width 1 μs)
Electrostatic Discharge	Connective discharge from EN61000-4-2: ±4 kV
Shock Endurance	10G X, Y, Z each direction(for 3 times)
Surge Voltage	500 V (Line-Line)
Ground Connection	Class 3 (Under 100 Ω)
Protection Classification	Front IP65
Insulation Coordination	Overvoltage category II



### 3.6 Structure Specifications

Model Name	TOPRW0500WD	TOPRW07□□WD	TOPRW0700WD NE	TOPRW10□□WD
Weight (Kg)	0.4	0.72	0.7	1.7
Cooling System	Natural Air Circulation			
Case Material	Plastic			

## Chapter 4 Part Names and General Specifications

### 4.1 TOPRW0500WD

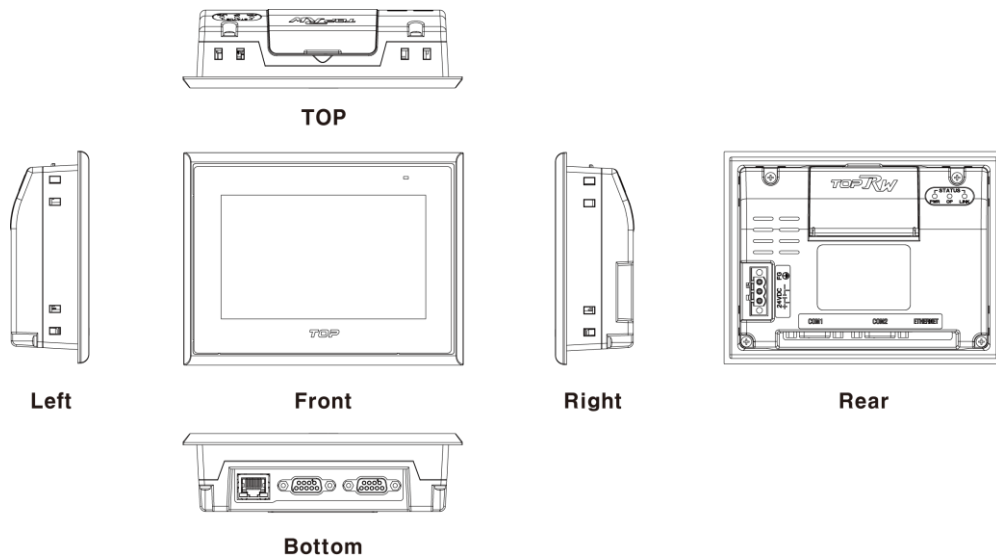

#### 4.1.1 External Dimension

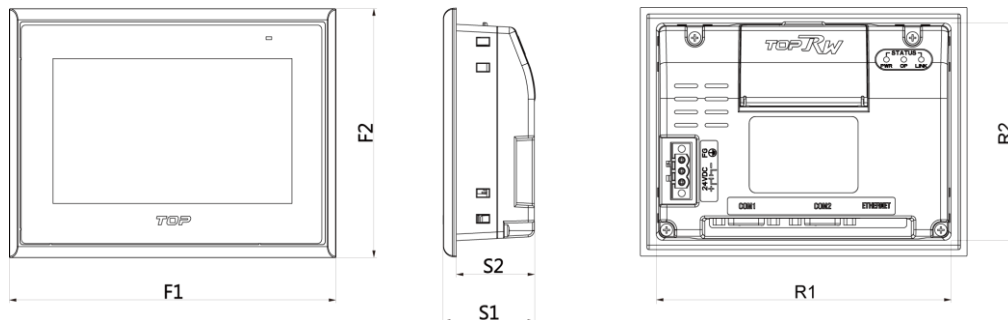

(mm)

Model	F1	F2	S1	S2	R1	R2
TOPRW0500WD	150	114	41.8	35.8	135	99

#### 4.1.2 Front Part Names and Specifications

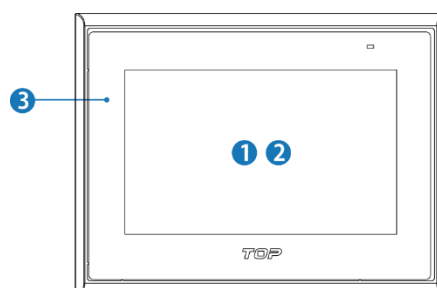

No.	Part	Description
①	LCD	TFT 16 M Color LCD
②	Touch Panel	Analog Touch
③	Front Sheet	Front Cover Sheet for Damp Proof and Dust Proof

4.1.3 Rear Part Names and Specifications

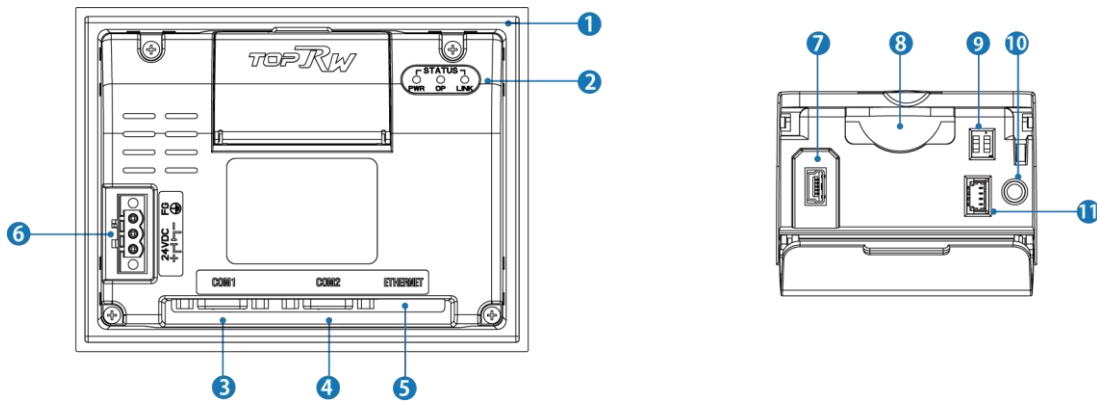

No.	Part	Form	Description
①	Rubber Packing	-	Silicone Gasket for Impact Buffering and IP Securing for Wall Mounting
②	Status LED	3ea	Status of Power, Communication and CPU
③	COM1 Connector	D-sub 9P	RS-232C Serial Comm. with PLC
④	COM2 Connector	D-sub 9P	RS-232C / 422 / 485 Serial Comm. with PLC (Switchable the Comm. Via Software)
⑤	ETHERNET Connector	RJ-45 x 1ch	10BASE-T / 100BASE-Tx, Auto-MDIX
⑥	Power Input Terminal	TB 5 mm 3P	Power Supply of Main Unit (DC 24 V)
⑦	USB Connector	MINI USB AB Type	USB Connectors for Storage Options
⑧	SD Card Slot	SD Card Slot	SD Card Insert Connector
⑨	Mode Switch	DIP Switch 2	Set Up System Switch
⑩	Reset Switch	Tact Switch	System Reset Switch
⑪	Diagnose Connector	2 mm 4P	Diagnose System (Manufacturer Use Only)

4.2 TOPRW07□□WD / TOPRW0700WD NE

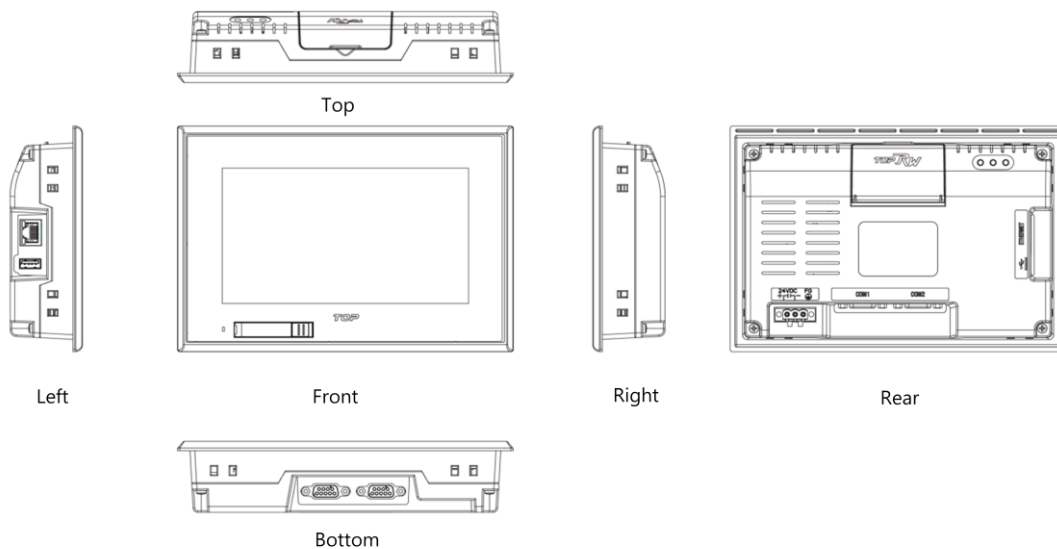

4.2.1 External Dimension

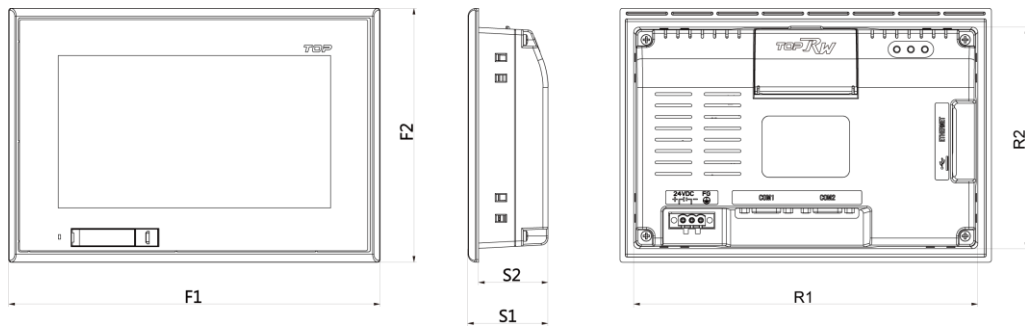

(mm)

Model	F1	F2	S1	S2	R1	R2
TOPRW07□□WD	212	145	45.6	39.6	196	126
TOPRW0700WD NE						

4.2.2 Front Part Names and Specifications

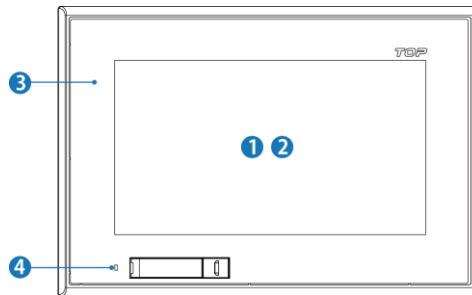

No.	Part	Description
①	LCD	TFT 16 M Color LCD
②	Touch Panel	Analog Touch
③	Front Sheet	Front Cover Sheet for Damp Proof and Dust Proof
④	USB Port	Project Upload / Download

4.2.3 Rear Part Names and Specifications

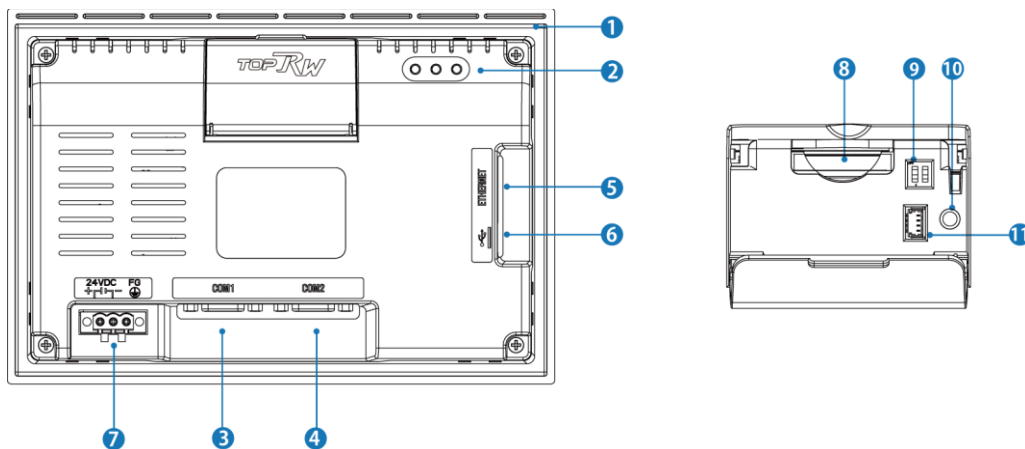

No.	Part	Form	Description	Adoptive Model
①	Rubber Packing	-	Silicone Gasket for Impact Buffering and IP Securing for Wall Mounting	Common
②	Status LED	3	Status of Power, Communication and CPU	Common
③	COM1 Connector	D-sub 9P	RS-232C Serial Comm. with PLC	Common
④	COM2 Connector	D-sub 9P	RS-232C / 422 / 485 Serial Comm. with PLC (Switchable the Comm. Via Software)	Common
⑤	ETHERNET Connector	RJ-45 x 1ch	10BASE-T / 100BASE-Tx, Auto-MDIX	TOPRW0700WD
⑥	USB Connector	Type-A x 1port	USB Connectors for Storage Options	Common
⑦	Power Input Terminal	TB 5 mm 3P	Power Supply of Main Unit (DC 24V)	Common
⑧	SD Card Slot	SD Card Slot	SD Card Insert Connector(*Option)	Common
⑨	Mode Switch	DIP Switch 2 Digit	Set Up System Switch	Common
⑩	Reset Switch	Tact Switch	System Reset Switch	Common
⑪	Diagnose Connector	2 mm 4P	Diagnose System (Manufacturer Only)	Common

### 4.3 TOPRW10□□WD

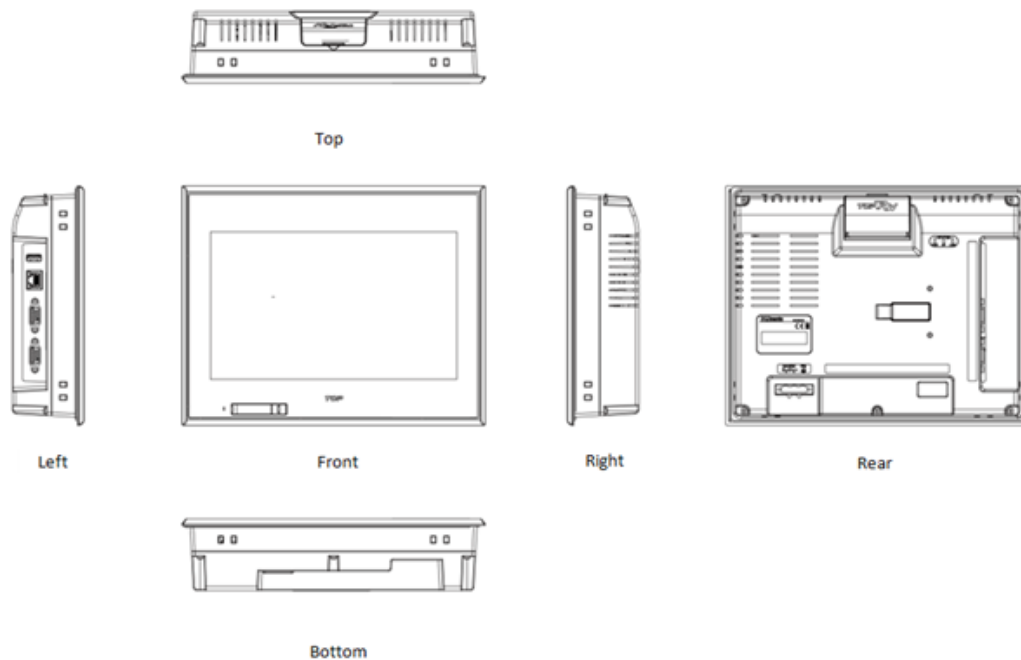

#### 4.3.1 External Dimension

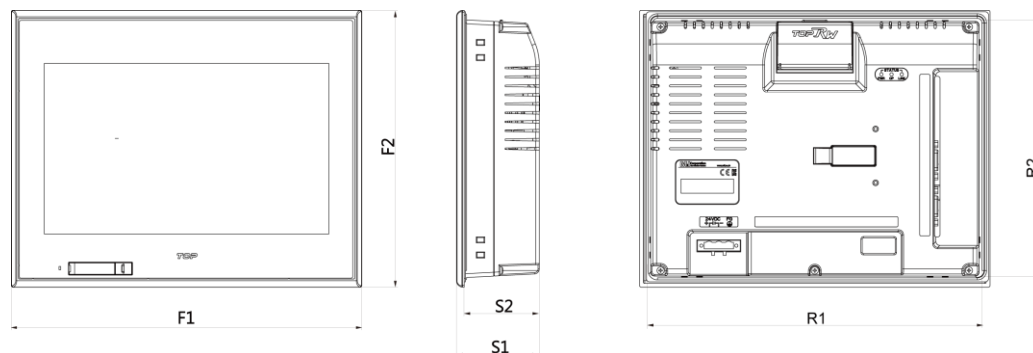

(mm)

Model	F1	F2	S1	S2	R1	R2
TOPRW10□□WD	274	216	64.7	58.7	260	202

### 4.3.2 Front Part Names and Specifications

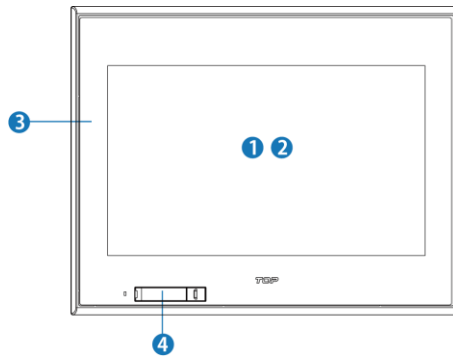

No.	Part	Description
①	LCD	TFT 16 M Color LCD
②	Touch Panel	Analog Touch
③	Front Sheet	Front Cover Sheet for Damp Proof and Dust Proof
④	USB Port	Project Upload / Download

### 4.3.3 Rear Part Names and Specifications

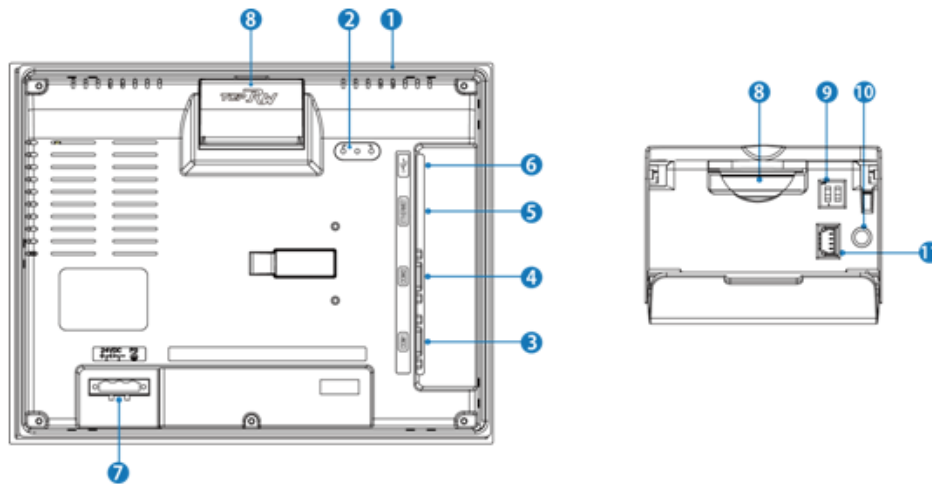

No.	Part	Form	Description
①	Rubber Packing		Silicone Gasket for Impact Buffering and IP Securing for Wall Mount
②	Status LED	3	Status of Power, Communication and CPU
③	COM1 Connector	D-sub 9P	RS-232C Serial Comm. with PLC
④	COM2 Connector	D-sub 9P	RS-232C / 422 / 485 Serial Comm. with PLC (Switchable the Comm. Via Software)
⑤	ETHERNET Connector	RJ-45 x 1ch	10BASE-T / 100BASE-Tx, Auto-MDIX
⑥	USB Connector	Type-A x 1port	USB Connectors for Storage Options
⑦	Power Input Terminal	TB 7.6 mm 3P	Power Supply of Main Unit (DC 24V)
⑧	SD Card Slot	SD Card Slot	SD Card Insert Connector(*Option)
⑨	Mode Switch	DIP Switch 2 ea	Set Up System Switch
⑩	Reset Switch	Tact Switch	System Reset Switch
⑪	Diagnose Connector	2 mm 4P	Diagnose System (Manufacturer Only)

## Chapter 5 External Device Interface

In order for the main unit to communicate with an external device, it is necessary to connect the two devices by referring to the following.

### 5.1 Serial Communication Specifications

#### 5.1.1 RS-232C

Items		Contents
Protocol		Full Duplex
Synch		Asynchronous
Communication Distance		About 15 m
Type of Connection		1:1
Control Code		ASCII Code or HEXA Code
Transmission Speed		2400, 4800, 9600, 19200, 38400, 57600, 76800, 115200, 187500 bps
Data Type	Data Bit	7, 8 bit
	Parity Bit	NONE, ODD, EVEN Parity
	Stop Bit	1, 2 bit
Modular Jack		D-sub 9 Pin

#### 5.1.2 RS-422/485

Items		Contents
Protocol		Full Duplex / Half Duplex
Synch		Asynchronous
Communication Distance		About 500 m
Type of Connection		1:N (N ≤ 31)
Control Code		ASCII Code or HEXA Code
Transmission Speed		2400, 4800, 9600, 19200, 38400, 57600, 76800, 115200, 187500 bps
Data Type	Data Bit	7, 8 bit
	Parity Bit	NONE, ODD, EVEN Parity
	Stop Bit	1, 2 bit
Modular Jack		D-sub 9 Pin

#### 5.1.3 COM1 Connector pin number and Signal name

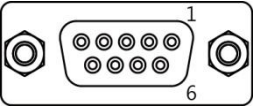
Type	Pin No.	Signal	Direction	Contents
 <p>9Pin Female</p>	1	NC	-	N/A
	2	RD (Rx/D)	Input	RS-232C Data Receive
	3	SD (Tx/D)	Output	RS-232C Data Send
	4	NC	-	N/A
	5	SG	-	Signal Ground
	6	NC	-	N/A
	7	<sup>1)</sup> 전원	-	+5V, 0.2A
	8	<sup>2)</sup> GND	-	Power Ground
	9	NC	-	N/A

<sup>1)</sup>, <sup>2)</sup> When you need VCC for external equipment, use 7.VCC and 8.VCC GND that output is 0.2A

## 5.1.4 COM2 Connector pin number and Signal name

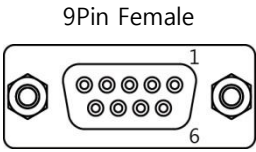
Type	Pin No.	Signal	Direction	Contents
	1	RDA (RD+)	Input	RS-422 / 485Data Receive(+)
	2	RD (RxD)	Input	RS-232C Data Receive
	3	SD (TxD)	Output	RS-232C Data Send
	4	RDB (RD-)	Input	RS-422 / 485Data Receive(-)
	5	SG	-	Signal Ground
	6	SDA (SD+)	Output	RS-422 / 485Data Send(+)
	7	NC	-	N/A
	8	NC	-	N/A
	9	SDB (SD-)	Output	RS-422 / 485Data Send(-)

\* Be sure to connect the RD and SD to the RS-232C communication line by crossing each other with a Twisted Pair Cable.

\* Please connect SG directly.

\* RS-422/485 communication line must use RDA and RDB as Twisted Pair Cable, SDA and SDB as Twisted Pair Cable.

\* Do not use shield wire of communication line as signal ground. It may cause communication failure.

## 5.2 Ethernet Communication Specifications

## 5.2.1 Ethernet

Items	Specifications
Ethernet Method	IEEE 802.3i / IEEE 802.3u, 10BASE-T / 100BASE-Tx
Speed	10M / 100Mbps
Communication Method	baseband
Switching Method	Auto-MDIX
Maximum Segment Length	100 m (Product Between Hub)
Communication Cable	UTP (Unshielded Twisted Pair)
Modular Jack	RJ-45 x 1 ch

## 5.2.2 RJ-45 Pin Layout

Type	Pin No.	Color	Signal
	1	Orange / White	TD+
	2	Orange	TD-
	3	Green / White	RD+
	4	Blue	Not Available in 10BASE-T
	5	Blue / White	Not Available in 10BASE-T
	6	Green	RD-
	7	Brown / White	Not Available in 10BASE-T
	8	Brown	Not Available in 10BASE-T

\* When HUB is using, Straight cable should be used.

Ex) Straight Cable Wiring: Connect 1:1 according to the wiring diagram above.

\* In case of do not using HUB, do not use HUB. When it is connected directly, Cross Cable should be used.

Ex) Cross Cable Wiring: In the above wiring diagram, TD+ and RD+ are changed, and TD- and RD- are exchanged.

## 5.3 USB Communication Specifications

### 5.3.1 USB Host

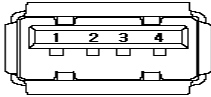
Type	Items	Specifications
	USB Interface	EHCI / OHCI Specification Version 1.0, USB 2.0 / 1.1 Compatible
	Communication Method	Control / Bulk
	Transfer Speed	Max. 480 Mb/s
	Support Device	USB Storage (FAT16 / FAT32 File Format Available)
	Connector Type	USB Type-A x 1 port

### 5.3.2 USB OTG

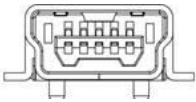
Type	Items	Specifications
	USB Interface	USB 2.0
	Communication Method	Interrupt / Bulk / Isochronous
	Transfer Speed	Max. 480 Mb/s
	Supporting OS	Windows 98SE / 2000 / XP / VISTA / 7 / 10 (32 / 64bit)
	Cable Length	Recommended: 3 m cable (manufacturer). Use ≤ 1.5 m if purchased separately.
	Connect Type	USB Mini-B (Female) x 1 port
	Connect Method	TOPRW05
TOPRW07/10		Connect Via USB Front of Display Module

## Chapter 6 Installation Warning

### 6.1 Installation Requirement

- (1) It should be installed within  $-10 \sim 50 \text{ }^{\circ}\text{C}$  and  $10 \sim 90 \text{ \%RH}$ , otherwise the screen may be changed or cause malfunction and damage.
- (2) Be sure that heat from surrounding equipment does not cause product to exceed its standard operating temperature.
- (3) In order to minimize external mechanical hazards, please control the mechanical hazards of the surrounding environment.

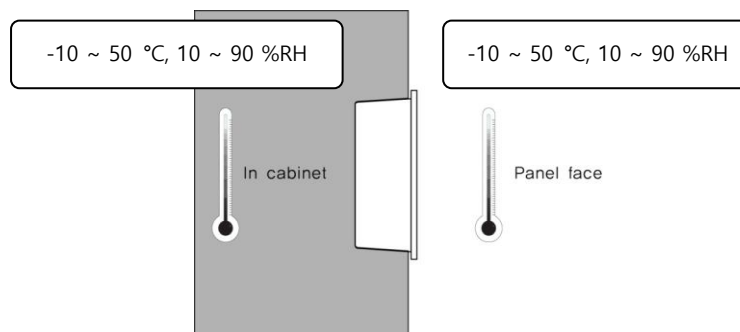



## 6.2 Installation Procedure Warning

In order to install this product, please follow the following procedure.

### 6.2.1 Panel Cut

Make a panel cut which product is mounted and insert the product to the panel from the front side.

#### (1) The Size of Panel Cut

Making the Panel Cut (Mounting Size) per each TOPRW Series as below Table, Before Installation.

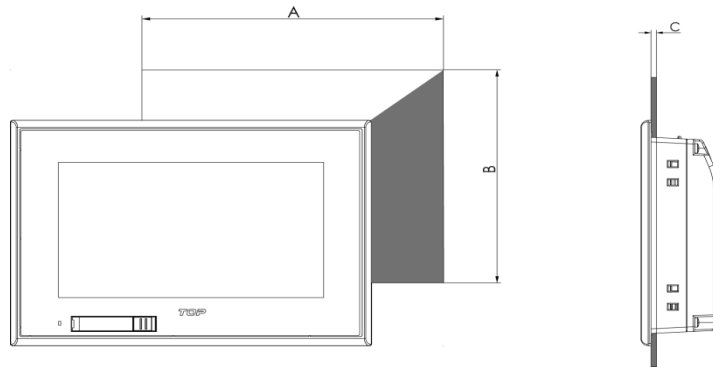

Model	A	B	C
TOPRW0500WD	136 (+1.0 / 0)	100 (+1.0 / 0)	1 ~ 5
TOPRW07□□WD	197 (+1.0 / 0)	127 (+1.0 / 0)	
TOPRW0700WD NE			
TOPRW10□□WD	260 (+1.0 / 0)	202 (+1.0 / 0)	

(mm)

#### (2) Clamp Fixing Warning

Install clamps with this product should be installed as follows to maintain the IP performance of the device.

a. Insert the clamp into the slot of the product.

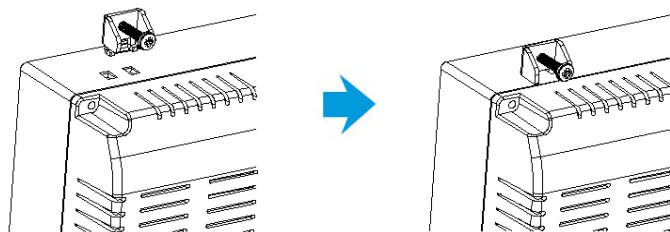

b. Screw the unit into the panel cut with a screwdriver.

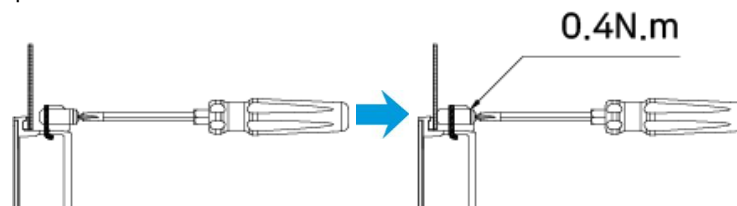



If the screw is over tightened, it may cause the front deformation, thus resulting the touch sensor can't work properly Tighten the screws to a torque of 0.4 N.m.

\*Caution: If the clamp is screwed less than 0.4 N.m, IP performance is not working well.

# Chapter 7 Wiring Warning

## 7.1 Power Cable Wiring Warning

(1) The Power cable should have the following specification.  Warning

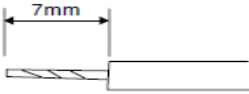
Power Cable Specification	0.75 ~ 2.5 mm <sup>2</sup> (18 ~ 12 AWG)
F.G Cable Specification	Over 2 mm <sup>2</sup> (14 AWG)
Conductor Type	Simple or Standard Wire
Bolt tightening force	≥ 0.6 N.m  Warning
Conductor Length	
Temperature rating of the field installed conductors	65 °C

(2) The Power terminal should have the following specification.  Warning

To Prevent wearing of cable and to enhance electronic transmission, please use a pin type conductor for power cable and ground wiring.

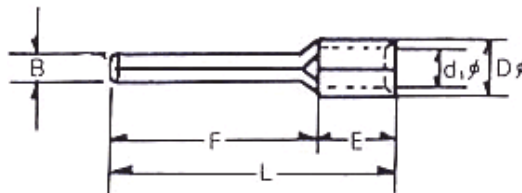

(mm)

B	L	F	E	D	d
1.8 ~ 2.0	14 ~ 22	8 ~ 14	5	3.3 ~ 3.8	2 ~ 2.5

(3) Wiring of power cable is as follows.  Warning

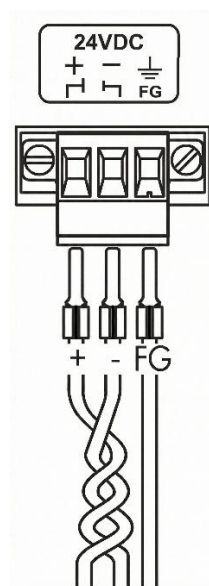

## 7.2 Ground Wiring Warning

- (1) The product has enough anti-noise measure, so except that there are many noises. Especially the ground is needed. When doing ground, please refer to the followings.
- (2) The ground should be the exclusive ground. The ground should be type Class 3 ground (ground resistor is less than 100  $\Omega$ ).
- (3) When the exclusive ground cannot be set, do common ground like figure B).

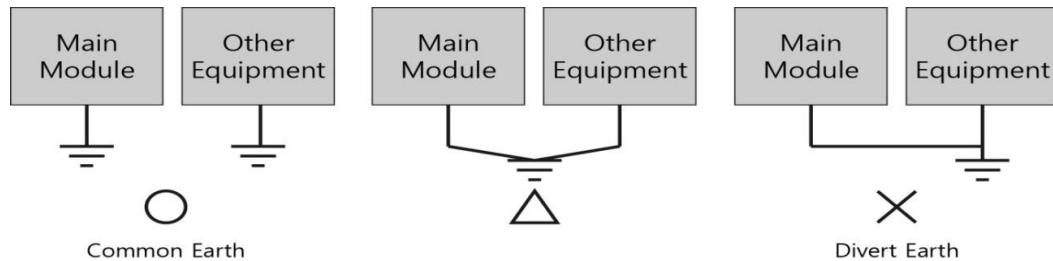

Fig. Grounding Example Diagram

- (4) Use the cable more than 2mm<sup>2</sup>. Put the point of the ground near product and shorten Ground line.

## Chapter 8 Maintenance

### 8.1 Cleaning the Display

When the surface or frame of the display become dirty, spray the cleaning solution onto a soft cloth and wipe the device. Do not spray the cleaning solution directly onto the device.

### 8.2 Periodic Check Points

Check the followings periodically for best condition of the device.

- (1) Environment
  - a. Is the operating temperature within the allowable range (-10 ~ 50 °C)?
  - b. Is the operating humidity within the allowable range (10 ~ 90 %RH)?
  - c. Is the Surrounding pollution no corrosive gas?
- (2) Power
  - a. Is the input voltage within the change range?
- (3) Related Items
  - a. Check the guarantee duration of LCD Backlight by eye.
  - b. Check the touch pad there is no damage, scratch or pollution by eye.

### 8.3 Problems with the Device Warning

- a. If there is a problem during operation, stop using it and contact the A/S department of M2I Corporation, which is indicated on the product label.
- b. Only the authorized worker from M2I Corporation can check and repair problems related to malfunction of the machine.
- c. If the problem cannot be solved at the installation site, the equipment can be collected and moved to M2I Corporation.

#### M2I Corporation

11-35, Simin-daero 327beon-gil, Dongan-gu, Anyang-si, Gyeonggi-do 14055, Korea,  
Tel: +82-70-465-3366, Fax: +82-31-465-3355, www.m2i.co.kr

- d. The manufacturer, M2I Corporation, is not responsible for damage or malfunction of the equipment caused by the use conditions of the user beyond the installation and use standards described in the manual.
- e. If there is a high electromagnetic noise, put ferrite core on main power cable and field cable. The noise of power cable and communication cables can be high under the installation circumstances.
- f. When the USB device does not work well by a noise, put ferrite core on each end side of cable to improve an endurance against it.

#### 8.4 Setting System Recovery Mode

- a. If the system fails to boot normally due to a problem during operation, the built-in recovery function can be used to maintain the factory default state. Please note that the built-in project will be deleted when using the recovery mode.
- b. After opening the rear cover, you can adjust the setting switch. Keep the "Normal" state when booting normally. If the system is recovering, turn off the power and set it to "Factory Reset".
- c. When the recovery is completed, the buzzer sounds, then turn off the power and reset to "Normal" state.

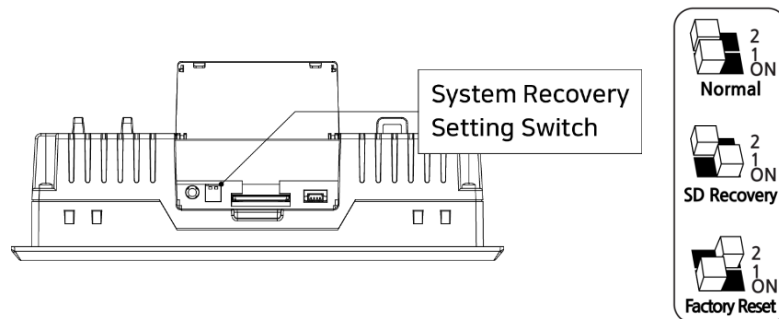

## Chapter 9 Products Label / Warning Label

### 9.1 TOPRW0500WD

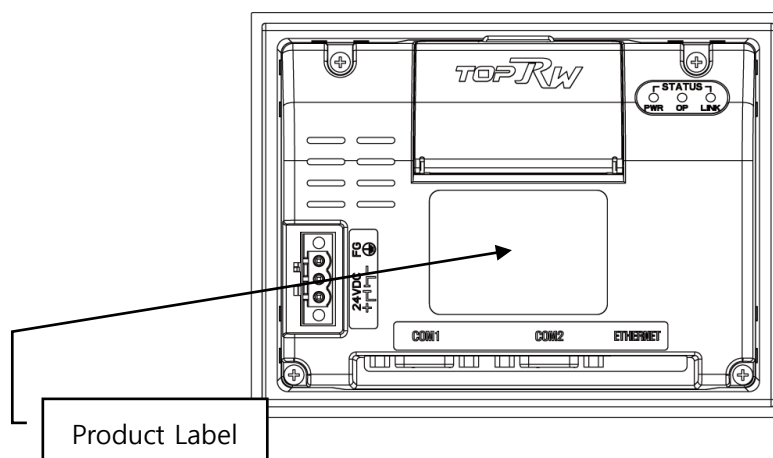

9.2 TOPRW07□□WD / TOPRW0700WD NE / TOPRW10□□WD

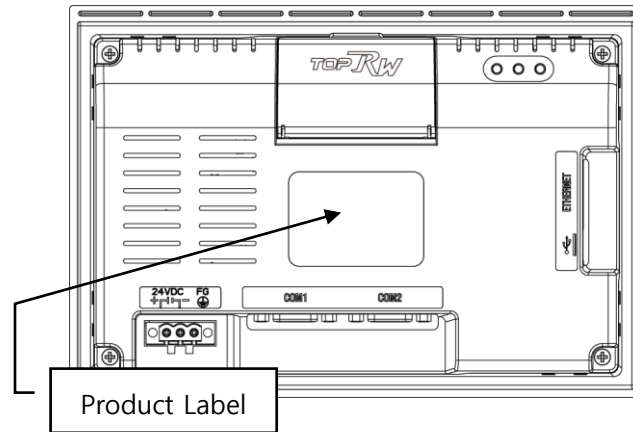

	<b>Industrial HMI Touch Panel</b>
Manufacture(AS)	<b>M2 Corporation</b> 工业操作终端 <span style="float: right;">Service &amp; Support www.m2i.co.kr</span>
*1) Model	<b>TOPRWXXXXX WD</b> <span style="float: right;">M2I Bldg, Simin-daero 327, Anyang-si, 14055</span>
*2) Power	IN(输入): 20~28V $\equiv$ class2, xxW <span style="float: right;">Made In Korea</span>
Battery	Inside Cell(内部电池): MS920SE <span style="float: right;">韩国制造</span>
S / N (产品系列号):	-
Operation Temp.	Tamb (使用温度): $-10^{\circ}\text{C} \leq T_a \leq +50^{\circ}\text{C}$
Warning	Ingress Protection(入口保护): IP65(Front/正面) V1
	⚠ If you need change the inside battery please contact the A/S center Si vous devez remplacer la batterie interne, veuillez contacter le centre de service après-vente
	⚠ For use on a flat surface of a Type 1 Enclosure À utiliser sur une surface plane d'un boîtier de type 1.
Certificates & no.	<b>WARNING-POTENTIAL ELECTROSTATIC CHARGING HAZARD</b> AVERTISSEMENT - RISQUE POTENTIEL DE CHARGE ÉLECTROSTATIQUE
	⚠ See Instructions Voir les instructions.
	 R-R-M2I-ORWXXXXWD   

- \*1),2)Model Names and Power Specifications:
- TOPRW0500WD: 24 Vdc, 12 W, Class 2 should be used
  - TOPRW07□□WD: 24 Vdc, 12 W, Class 2 should be used
  - TOPRW0700WD NE: 24 Vdc, 12 W, Class 2 should be used
  - TOPRW10□□WD: 24 Vdc, 15 W, Class 2 should be used.

Copyright: M2I corporation 2026.01 www.m2i.co.kr

- Please read related contents in this manual when you use M2I product, and operate the product staying safe with appropriate handling.
- This manual should be stored in secured and appointed place so that it can be read in any needs.