

M2I Corporation



Industrial HMI Touch Panel

TOPRE Series Hardware Manual

Thank you for purchasing the industrial HMI touch panel series of M2I corporation.

Please read this manual carefully to know installing, wiring, operating this equipment for safe use of this product.

Contents





Chapter 1. Safety Precautions.....	3
■ Before using the product.....	3
■ General Precautions.....	3
■ Design Precautions.....	3
■ Wiring Precautions	3
Chapter 2. Overview.....	5
2.1 Introduction of Products.....	5
2.2 Package Contents.....	5
Chapter 3. General Specifications	7
3.1 Power Specifications	7
Chapter 4. Part Names and General Specifications.....	8
4.1 TOPRE0300QD / TOPRE0400WD	8
4.2 TOPRE0700WD.....	10
Chapter 5. External Device Interface.....	12
5.1 Serial Communication Specifications	12
5.1.1 RS-232C.....	12
5.1.2 RS-422/485.....	12
5.2 RJ-45 Pin Layout	13
5.3 USB Communication Specifications.....	13
5.3.1 USB Host (*Only TOPRE0700WD).....	13
5.3.2 USB OTG	14
Chapter 6. Installation	14
6.1 Installation Requirements	14
6.2 Installation Procedure.....	15
Chapter 7. Wiring	16
7.1 Power Wiring.....	16
Chapter 8. Maintenance	17
8.1 Cleaning the Display.....	17
8.2 Periodic Check Points.....	17
8.3 Problems with the Device.....	18
Chapter 9. Products and Warning Label Location	19
Chapter 10. Products Label.....	20

Chapter 1. Safety Precautions







■ Before using the product

To use the product safely and effectively, please read the contents of this manual thoroughly before use. Please keep to the safety precaution, for it is to prevent accidents and potential danger from occurring.

Safety precaution is classified into 'Warning' and 'Caution' and their meanings are as follows. Also the indicated illustrations on the product and in the manual have the following meanings.



 Warning	Violating the instruction may result in serious personal injury or death.
 Caution	Violating the instruction may result in slight personal injury or product damage.
	Be cautious, for danger may be present.
	Be cautious, for there is a possibility of an electric shock.

■ General Precautions Caution



-  Do not press the screen with a hard or sharp object (awl, screwdriver, pen) with too strong a force.
It may cause malfunction of touch due to damage of the front sheet.
-  Do not use or store in an environment with high vibration.
-  Do not allow foreign objects such as water, liquids, or metal powders to enter the product. This may cause breakage or electric shock.
-  Do not allow foreign objects such as water, liquids, or metal powders to enter into the front(screen) protective sheet. The screen may be invisible or may cause a malfunction of the touch.
-  Use the radio or mobile phone at least 30cm away from the main unit.
-  Two or fewer bright spots may appear on the LCD screen, and certain areas may appear brighter, but this is not a defect in LCD characteristics.
-  Do not store or operate in direct sunlight. Direct sunlight can change the properties of the LCD.

■ Design Precautions Warning

Install protection circuit on the outside of Products to protect the entire control system when external power supply or Products have problems.

-  As the malfunction & incorrect result of Products could damage the stability of the entire systems and human body, you must install damage preventing interlock circuit such as emergency stop, Protective circuits, positioning upper and lower limit switch and interlock for forward/reverse operation.
-  When computer or other controllers communicate and exchange data with products or change operation mode of products, set up protective sequence program in PC or Controller for protecting system from communication error.
-  The output signal or communication lines should be separated from the power line or high tension wire. They should be installed 100mm (3.94 Inch) or more from each other.

■ Wiring Precautions Warning

-  Be sure the wiring is done correctly by checking the product's rated voltage and the terminal layout. Incorrect wiring could result in fire, damage or malfunctions.
-  Tighten the terminal screw with the specified torque. If the screws of terminal are loose, It could result in short circuit, fire, malfunctions. FG Terminal must be used a dedicated ground. Not doing so could

result in malfunctions.

- ❗ a. Grounding should be the Class 3 grounding. The cable for grounding should be more than 4mm².
- ❗ b. grounding point be closed to the products and make short the distance to the ground cable if possible.

Please see below.

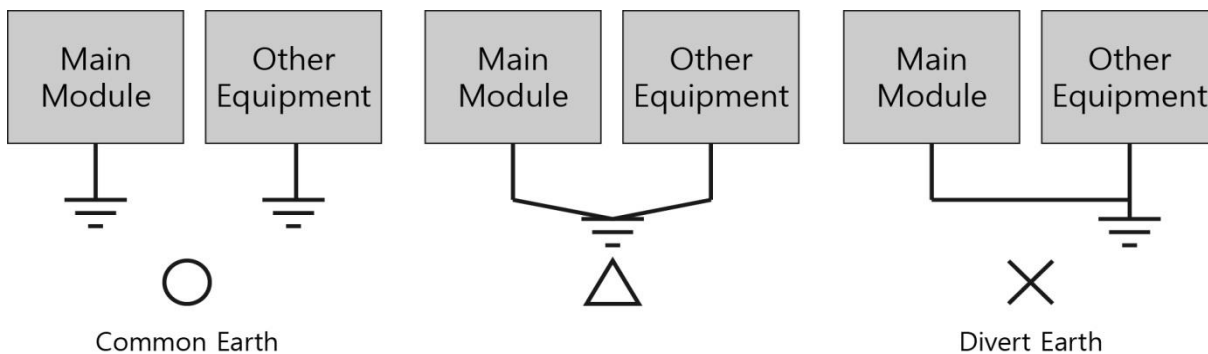

Fig. Grounding Example Diagram

■ **Installation Precautions** ⚠ **Caution**

Do not install the location which exceeds allowed temperature. Product can be damaged or shorten the life. Especially Install environment as below should be avoided.

- ⊘ Do not Install product to the place which the ambient temperature is out of limits, from 0°C to 50°C or on the surface of control board which high pressure equipment is installed.
- ⊘ Do not install to the place where strong shock or vibration continuously have impacted on product.
- ❗ The space between back of product and back of control board must be more than 100mm for maintenance and ventilation.
- ⊘ In order to improve water retention and ventilation, the space between the back of the main body and the console box should be 100mm or more, and install the cooling fan when installed in an enclosed space.

■ **Disposal Precautions** ⚠ **Caution**

When you dispose of product and battery, please treat it as industrial waste. It can create poisonous substances or explosion.

■ **Cell Type Battery Specifications** ⚠ **Warning**

Mounted on mainboard Model MS920SE Battery is not replaced by the user. Especially, it can be confused with similar battery and there is a danger of explosion. Do not change the battery. If you have a problem with the battery, please contact our Customer Support Center for replacement and inspection.

Item	Content
Battery Voltage	DC 3V
Battery Model	MS920SE(Rechargeable lithium / No need for replacement)
Battery lifetime	Permanent(In case of ambient temperature 25°C)
Battery Discharge	Last about 7 days After turn it off

* Depending on the model specifications are subject to change.

■ **All field-wiring connections to this unit shall be from Limited Voltage / Limited Current, below 24 Vdc isolated secondary source with an output fuse, or Class 2.**

Chapter 2. Overview







2.1 Introduction of Products

This industrial HMI touch panel is an industrial control device required in industrial field. It is a device based on RS-232C and RS-422/485, Ethernet which is used for the basic purpose of communication with another device(PLC).

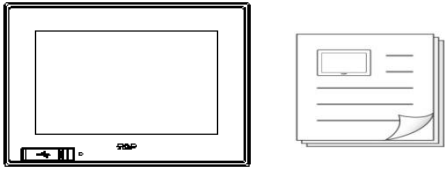
2.2 Package Contents

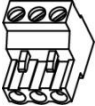
The components of the product are as follows.

Before using the product, please check that all of the following components are included.

Item	Figure	Quantity
Process Module And Manual	 The figure shows a rectangular process module with a screen and a manual with a folded corner.	1
Clamp	 A small metal clamp with a threaded end.	4
Power Connector	 A power connector with four terminals.	1
Accessories (Sold separate)	 USB Memory  USB Cable  SD Card  Front Protect Sheet	User Options

2.3 Explanation of Model Name

TOPRE	□□	□□	□	□	□□
Series	Display Size	Option	Resolution	Power	Ethernet Port
	03 : 3.5"	00 : Standard	Q : QVGA (320*240)	D: DC	NE : No Ethernet
	04 : 4.3"	XX : Reserved	V : VGA (640*480)		Blank : Ethernet support
	07 : 7.0"		S : SVGA (800*600)		
			X : XGA (1024*768)		
			W : WQVGA (480*272)		
			WVGA (800*480)		

*Product Wide model resolution

- TOPRE0400WD: WQVGA
- TOPRE0700WD: WVGA

Chapter 3. General Specifications

3.1 Power Specifications

Power	Input Voltage	DC24V		
	Input Voltage Range	DC 20~28V		
	Consumption Power	TOPRE0300QD	Under 12W	
		TOPRE0400WD	Under 12W	
		TOPRE0700WD	Under 12W	
	Voltage endurance	DC 24V, Within 10 ms		
Insulation Resistance	500V DC, 10 MΩ			

3.2 Memory Specifications

Screen Memory	64MB
Backup Memory	512KB: System buffer (10K Word), Including Alarm/Log/Recipe
Backup Period	Permanent
Real Time Clock	Built in(by Battery)

3.3 Environment Specifications

Operation Temperature (°C)	-10 ~ +50
Storage Temperature (°C)	-20 ~ +60
Operation Humidity (%RH)	0 ~ 90 (No dew)
Atmosphere	No corrosive gas
Vibration Endurance	Amplitude: 10≤F < 25 Hz(2G) X,Y,Z each direction(for 30 minutes)
Noise Immunity	1000Vp-p(Pulse width 1 μs)
Static Electricity Discharge	Connective discharge from EN61000-4-2: ±4 kV
Shock Endurance	10G X,Y,Z each direction(for 3 times)
Surge Voltage	500V(Line-Line)
Ground Connection	Class 3(Under 100Ω)
Protection Classification	Conform to IP65

3.4 Structure Specifications

	TOPRE0300QD	TOPRE0400WD	TOPRE0700WD
Weight	0.28	0.28	0.62
Cooling System	Natural Air Circulation		
Case Material	PC(Flameless)		

Chapter 4. Part Names and General Specifications

4.1 TOPRE0300QD / TOPRE0400WD

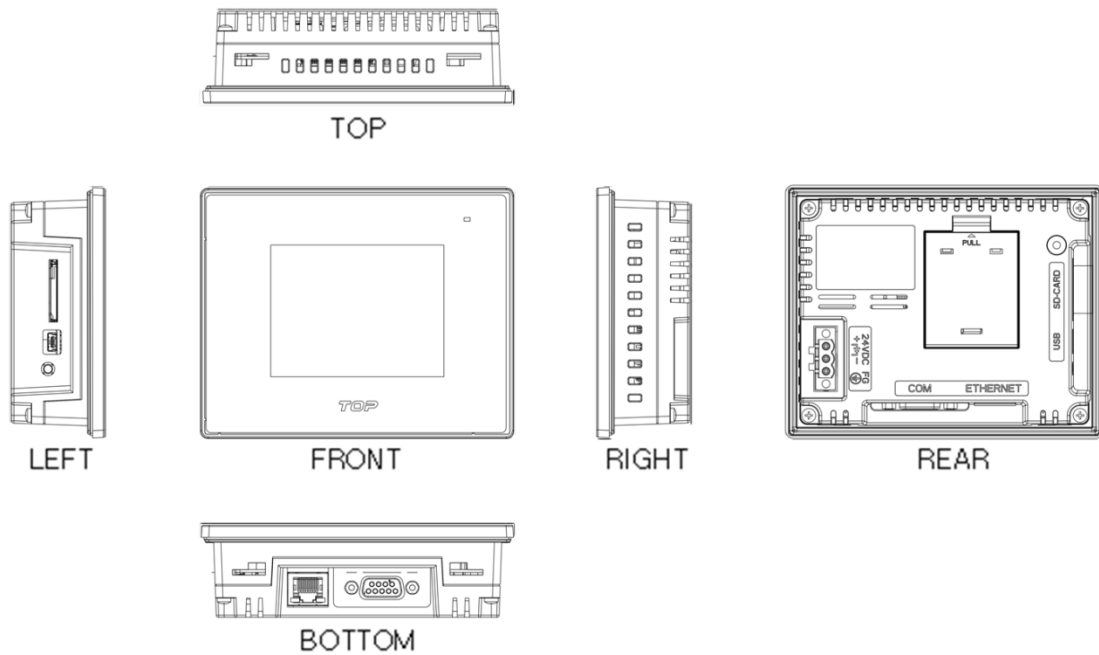

4.1.1 External Dimension

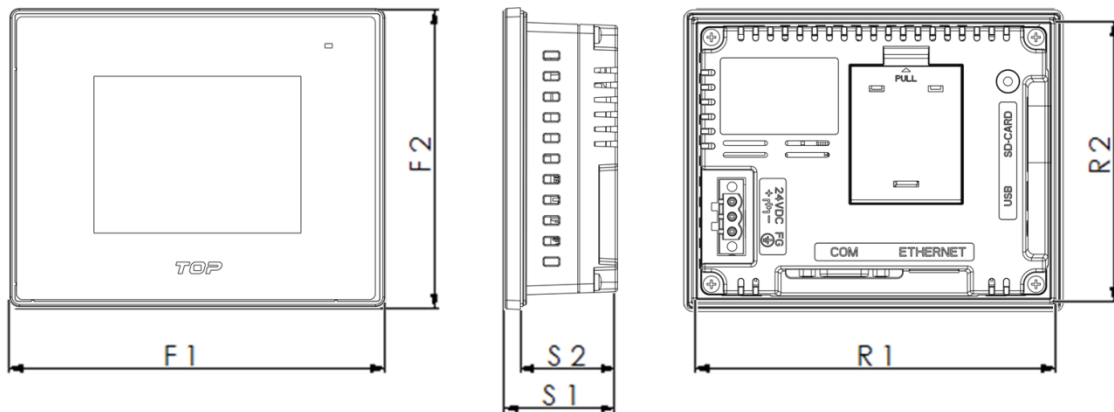

Model	F1(mm)	F2(mm)	S1 (mm)	S2 (mm)	R1(mm)	R2(mm)
TOPRE0300QD	128.6	102.6	38	32	118.7	92.7
TOPRE0400WD						

4.1.2 Front Part Names and Specifications

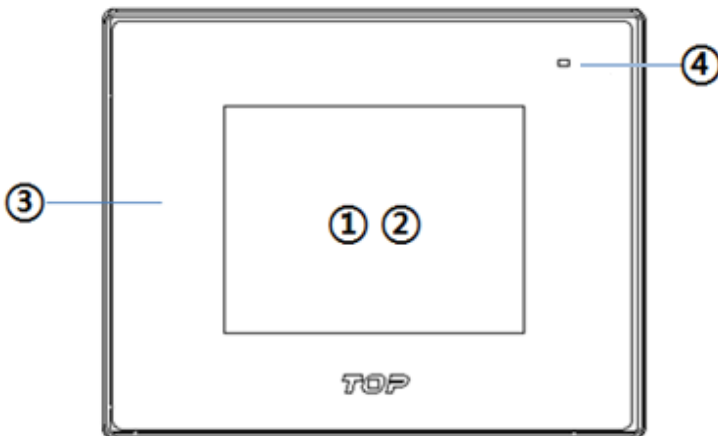

No.	Part	Description
①	LCD	TFT 16M Color LCD
②	Touch Panel	Analog Touch
③	Front Sheet	Front Cover Sheet for Damp Proof and Dust Proof
④	Operation LED	Product operation status LED

4.1.3 Rear Part Names and Specifications

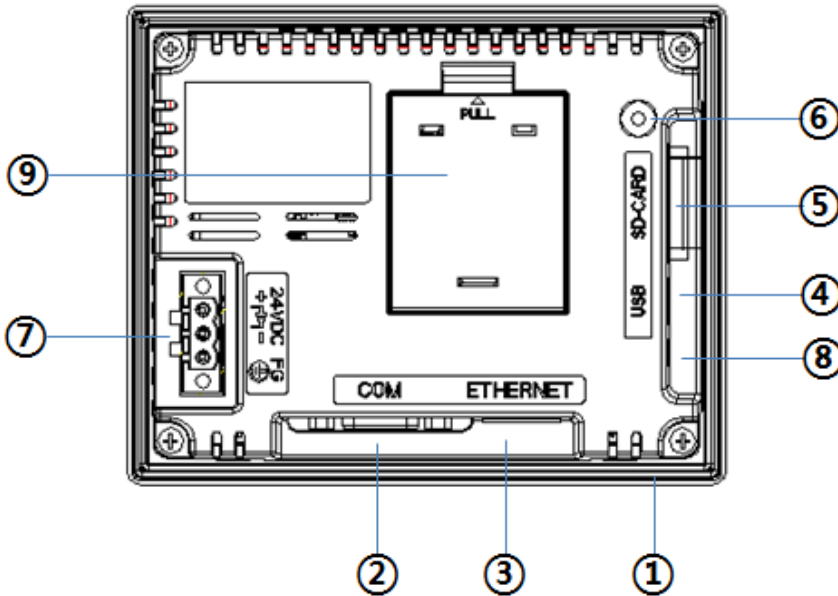

No.	Part	Form	Description
①	Rubber Packing	-	Silicone Gasket for Impact Buffering and IP Securing for Wall Mounting
②	COM Connector (COM1/2)	DSUB9 1EA	COM1: RS-232C, COM2: RS422/485 Serial Comm. with PLC (Switchable the Comm. Via Software)
③	ETHERNET Connector	RJ45	10BASE-T/100BASE-TX, Auto-MDIX
④	USB Connector	MINI USB Type AB	USB Connectors for Storage Options
⑤	SD Card Slot	SD Card Slot	SD Card Insert Connector
⑥	SD Card LED	LED	SD Card operation status LED
⑦	Power Input Terminal	TB 5mm 3P	Power Supply of Main Unit(DC 24V)
⑧	Reset Switch	Tact Switch	System Reset Switch
⑨	Built-in cover	-	Cover for manufacturer maintenance

4.2 TOPRE0700WD

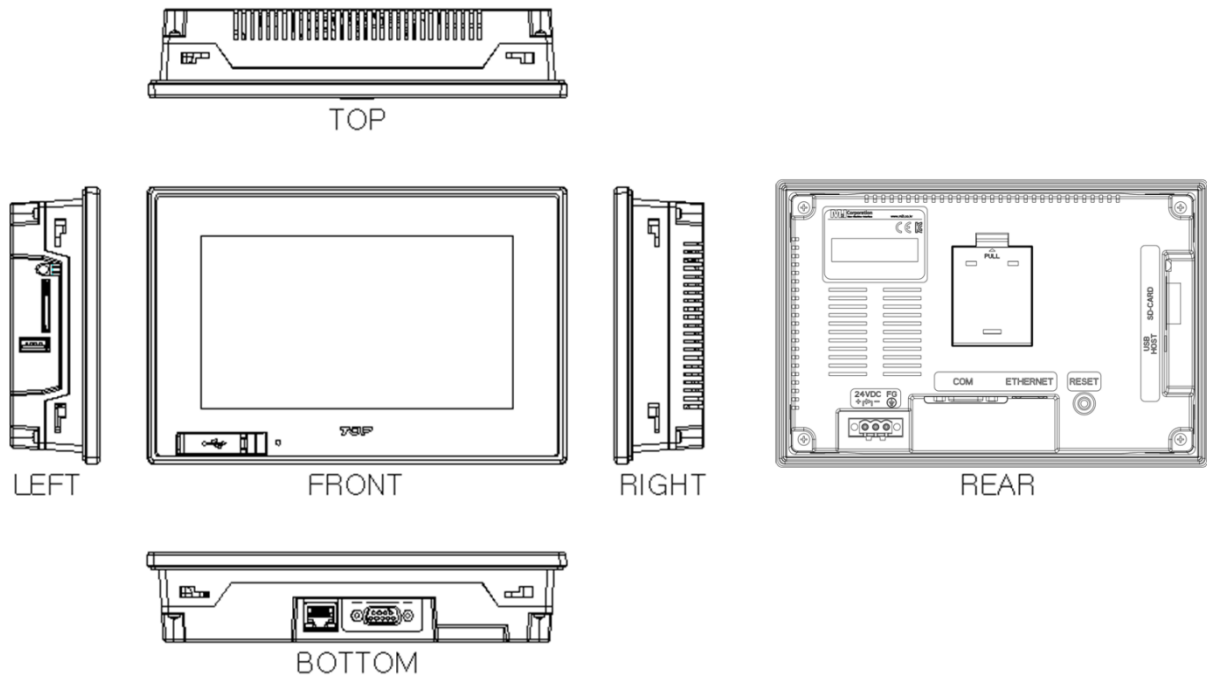

4.2.1 External Dimension

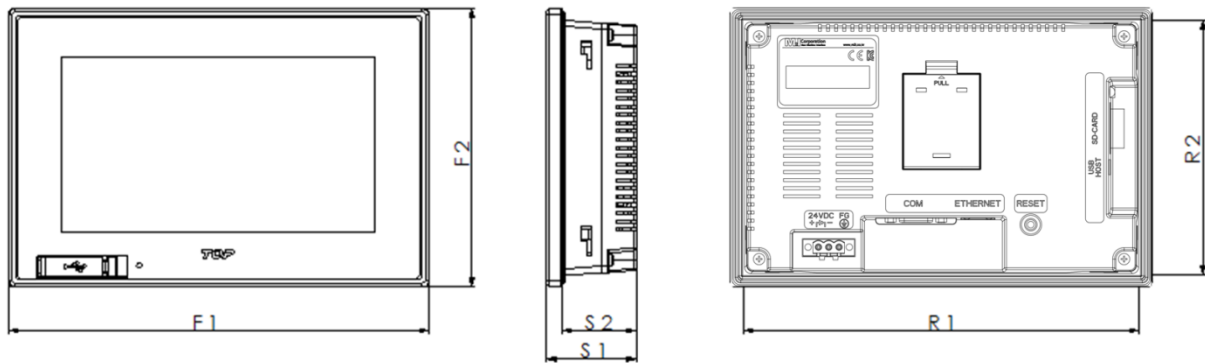

Model	F1(mm)	F2(mm)	S1 (mm)	S2 (mm)	R1(mm)	R2(mm)
TOPRE0700WD	206.5	136.5	44	36.7	194.3	124.3

4.2.2 Front Part Names and Specifications

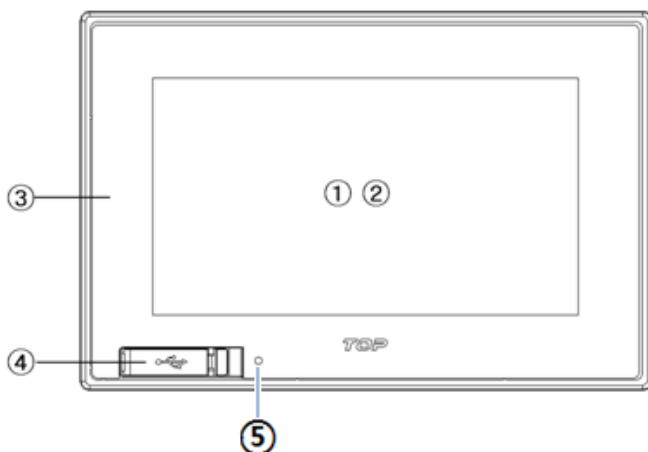

No.	Part	Description
①	LCD	TFT 16M Color LCD
②	Touch Panel	Analog Touch
③	Front Sheet	Front Cover Sheet for Damp Proof and Dust Proof
④	USB Port	USB Download/Upload Port
⑤	Operation LED	Product operation status LED

4.2.3 Rear Part Names and Specifications

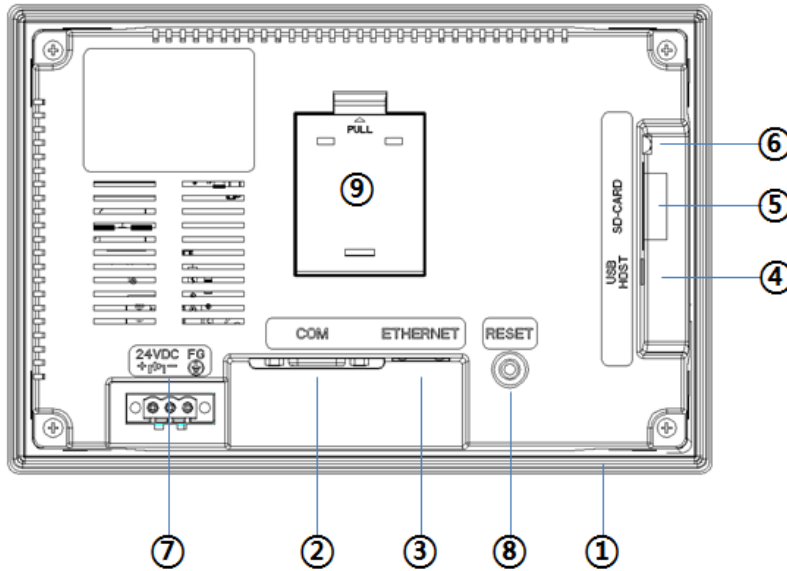

No.	Part	Form	Description
①	Rubber Packing	-	Silicone Gasket for Impact Buffering and IP Securing for Wall Mounting
②	COM Connector (COM1/2)	DSUB9 1EA	COM1: RS-232C, COM2: RS422/485 Serial Comm. with PLC (Switchable the Comm. Via Software)
③	ETHERNET Connector	RJ45	10BASE-T/100BASE-TX, Auto-MDIX
④	USB Connector	MINI USB Type AB	USB Connectors for Storage Options
⑤	SD Card Slot	SD Card Slot	SD Card Insert Connector
⑥	SD Card LED	LED	SD Card operation status LED
⑦	Power Input Terminal	TB 5mm 3P	Power Supply of Main Unit(DC 24V)
⑧	Reset Switch	Tact Switch	System Reset Switch
⑨	Built-in cover	-	Cover for manufacturer maintenance

Chapter 5. External Device Interface

In order for the main unit to communicate with an external device, it is necessary to connect the two devices by referring to the following.

5.1 Serial Communication Specifications

5.1.1 RS-232C

Items		Contents
Protocol		Full Duplex
Synch		Asynchronous
Communication Distance		About 15m
Type of Connection		1:1
Control Code		ASCII Code or HEXA Code
Transmission Speed		2400,4800,9600,19200,38400,57600,76800, 115200 bps
Data Type	Data Bit	7, 8 bit
	Parity Bit	NONE, ODD, EVEN Parity
	Stop Bit	1, 2 bit
Modular Jack		DSUB 9pin

5.1.2 RS-422/485

Items		Contents
Protocol		Full Duplex/Half Duplex
Synch		Asynchronous
Communication Distance		About 500m
Type of Connection		1:N (N ≤ 31)
Control Code		ASCII Code or HEXA Code
Transmission Speed		2400,4800,9600,19200,38400,57600,76800, 115200 bps
Data Type	Data Bit	7, 8 bit
	Parity Bit	NONE, ODD, EVEN Parity
	Stop Bit	1, 2 bit
Modular Jack		DSUB 9pin

5.1.3 COM Connector pin number and Signal name

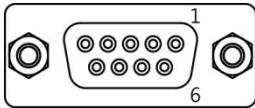
Type	Pin No.	Signal	Direction	Meaning
9Pin Female 	1	RDA(RD+)	Input	COM2: RS-422/485 Receive Data (+)
	2	RD(RxD)	Input	COM1: RS-232C Receive Data
	3	SD(TxD)	Output	COM1: RS-232C Send Data
	4	RDB(RD-)	Input	COM2: RS-422/485 Receive Data (-)
	5	SG	-	Signal Ground
	6	SDA(SD+)	Output	COM2: RS-422/485 Send Data(-)
	7	-	-	N/A
	8	VCC GND	GND	Power Ground
	9	SDB(SD-)	Output	COM2: RS-422/485 Receive Data (-)

- Be sure to connect the RD and SD to the RS-232C communication line by crossing each other with a Twisted Pair Cable. Please connect SG directly.
- RS-422/485 communication line must use RDA and RDB as Twisted Pair Cable, SDA and SDB as Twisted Pair Cable.
- Do not use shield wire of communication line as signal ground. It may cause communication failure.

5.2 Ethernet Communication Specifications

5.2.1 Ethernet

Item	Specification
Ethernet Method	IEEE802.3i/IEEE802.3u, 10BaseT / 100BaseT
Speed	10M/100Mbps
Communication Method	Base Band
Switching Method	AUTO MDIX
Maximum Segment Length	100m(Hub between product)
Communication Cable	UTP(Unshielded Twisted Pair)
Modular Jack	RJ-45

5.2.2 RJ-45 Pin Layout

Type	Pin No.	Color	Signal
	1	Orange/White	TD+
	2	Orange	TD-
	3	Green/White	RD+
	4	Blue	Not Available in 10BaseT
	5	Blue/White	Not Available in 10BaseT
	6	Green	RD-
	7	Brown/White	Not Available in 10BaseT
	8	Brown	Not Available in 10BaseT

- When HUB is using, Straight cable should be used.
Ex) Straight Cable Wiring: Connect 1:1 according to the wiring diagram above.
- In case of do not using HUB,
Do not use HUB, when it is connected directly, Cross Cable should be used.
Ex) Cross Cable Wiring: In the above wiring diagram, TD+ and RD+ are changed, and TD- and RD- are exchanged.

5.3 USB Communication Specifications

5.3.1 USB Host (*Only TOPRE0700WD)

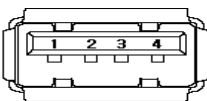
Type	Item	Specification
	USB Interface	EHCI/OHCI Specification Version 1.0, USB2.0/1.1 compatible
	Communication Method	Control/Bulk
	Transfer Speed	480Mb/s
	Support Device	USB Storage (FAT16/FAT32 File Format Available)
	Connector Type	Type A(1ch)

5.3.2 USB OTG

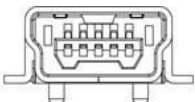
Type	Item	Specification
	USB Interface	USB 2.0
	Communication Method	Interrupt/Bulk/Isochronous
	Transfer Speed	480Mb/s
	Supporting OS	Windows 98SE/2000/XP/VISTA/7/10(32/64bit)
	Cable Length	1.5M(recommended to use M2I's Option Cable)
	Connect Type	MINI USB AB, Female
	Connect Method	Side Connected via USB terminal

Chapter 6. Installation  Warning

6.1 Installation Requirements

- (1) For the performance, ventilation and safe use of the equipment, keep the distance between the back of the main unit and each wall of the container at least 100mm and install the cooling fan when installed in an enclosed space.

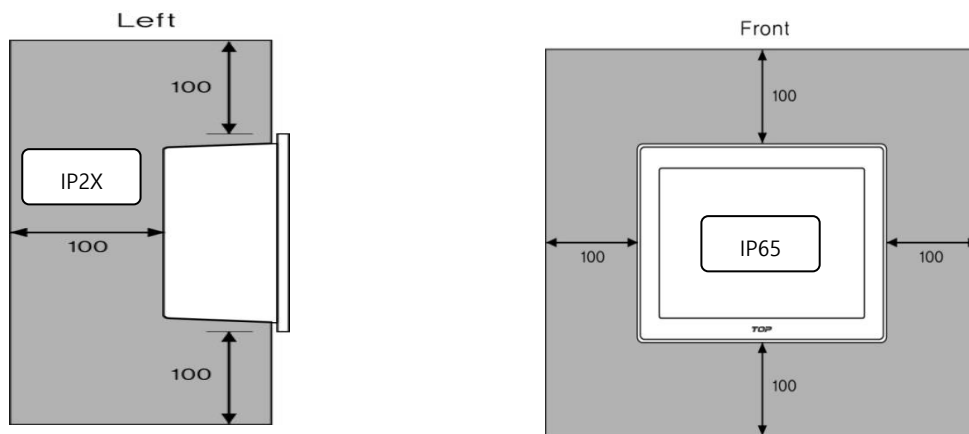

- (2) It should be installed within -10 ~ 50°C and 10~80% relative-humidity, otherwise the screen may be changed or cause malfunction and damage.
- (3) Be sure that heat from surrounding equipment does not cause product to exceed its standard operating temperature.
- (4) When you don't see within 30°, you may not see clearly.
When installing the product in a slanted position, The product screen should not incline more than 30°.
- (5) In order to minimize external mechanical hazards, please control the mechanical hazards of the surrounding environment.

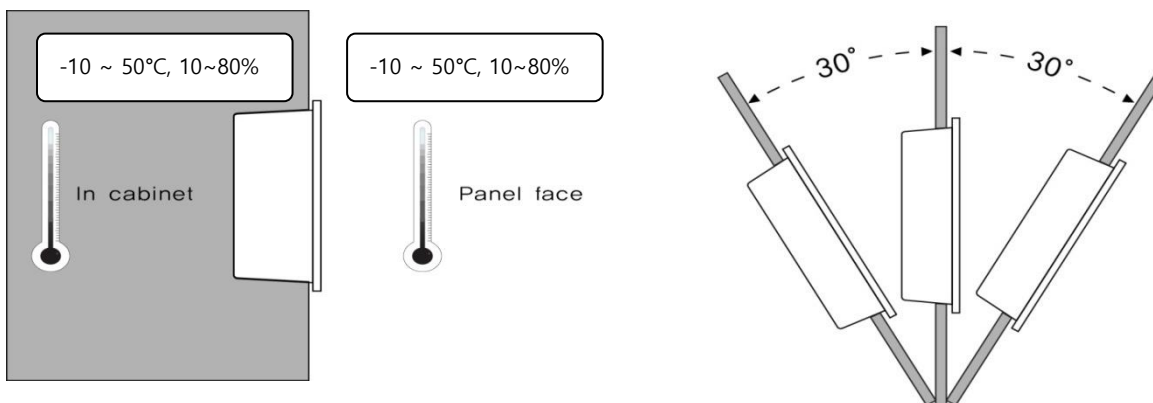

6.2 Installation Procedure

In order to install this product, please follow the following procedure.

(1) Panel Cut-out

Make a panel cut which product is mounted and insert the product to the panel from the front side.

- **The Size of Panel Cut**

Making the Panel Cut (Mounting Size) per each TOPRE Series as below Table, Before Installation.

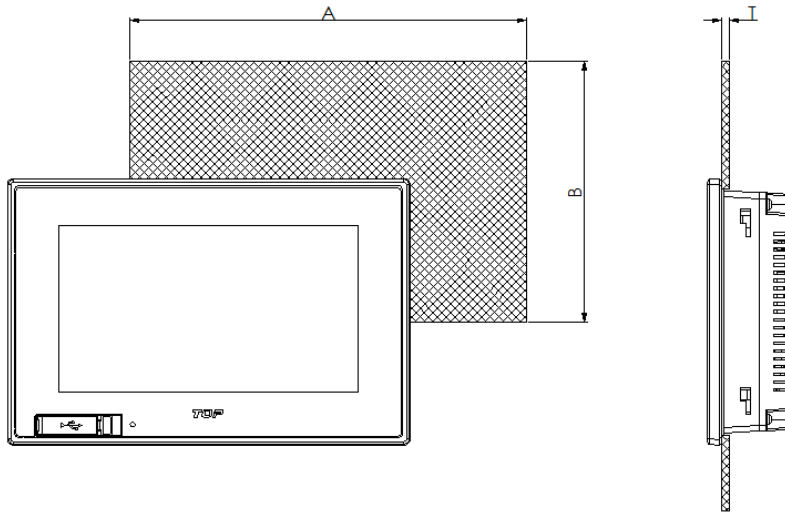

Model	A (mm)	B (mm)	T (mm)
TOPRE0300QD	121	95	1-5
TOPRE0400WD	121	95	
TOPRE0700WD	197	127	

(2) Fixing Warning

Install clamps with this product should be installed as follows to maintain the IP performance of the device.

- Insert the clamp into the slot of the product.

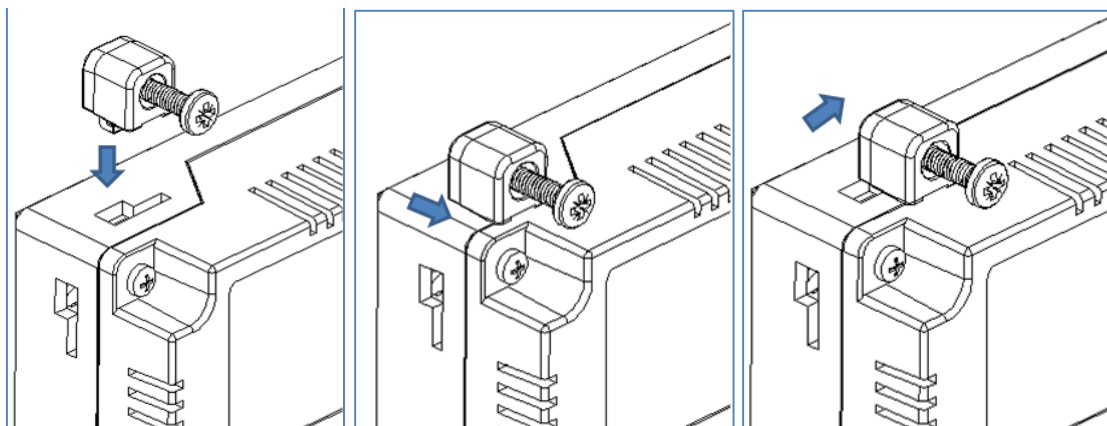

- b. Screw the unit into the panel cut with a screwdriver.

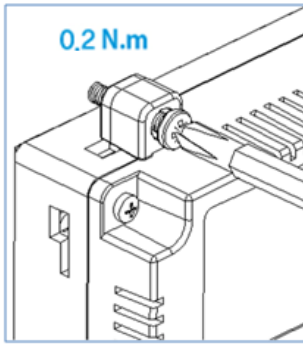

If the screw is over tightened, it may cause the front deformation, thus resulting the touch sensor can't work properly Tighten the screws to a torque of 0.2N.m.

Chapter 7. Wiring Warning

7.1 Power Wiring Warning

(1) The Power cable should have the following specification.

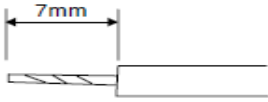
Power Cable Specification	0.75~2.5mm ² (18~12AWG)
F.G Cable Specification	Over 4mm ² (11AWG)
Conductor Type	Simple or Standard Wire
Bolt tightening force	≥ 0.2N.m.
Conductor Length	
Temperature rating of the field installed conductors	65°C Only

(2) The Power terminal should have the following specification.

Caution: The use of the Pin Terminal when installing the power supply and ground terminal is important for maintaining the performance of the device. Failure to install power and ground using the same Pin Terminal as below may cause explosion due to spark due to abnormal cable loss.

Therefore, please be sure to familiarize yourself with how to use Pin Terminal below.

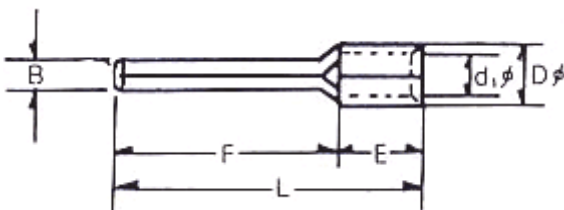

B	L	F	E	D	d
1.8~2.0	22~18	12~14	5	3.3~3.8	2~2.5

(3) Wiring of power is as follows.  Warning

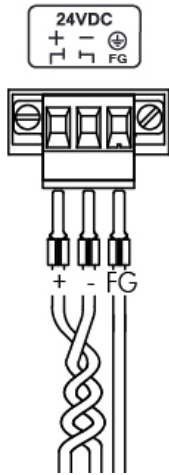

7.2 Ground Wiring Warning

(1) The product has enough anti-noise measure, so except that there are many noises.

Specially, the ground is not needed. When doing ground, please refer to the followings.

(2) The ground should be the exclusive ground.

The ground should be type Class 3 ground (ground resistor is less than 100Ω).

(3) When not doing the exclusive ground, do common ground like figure B).

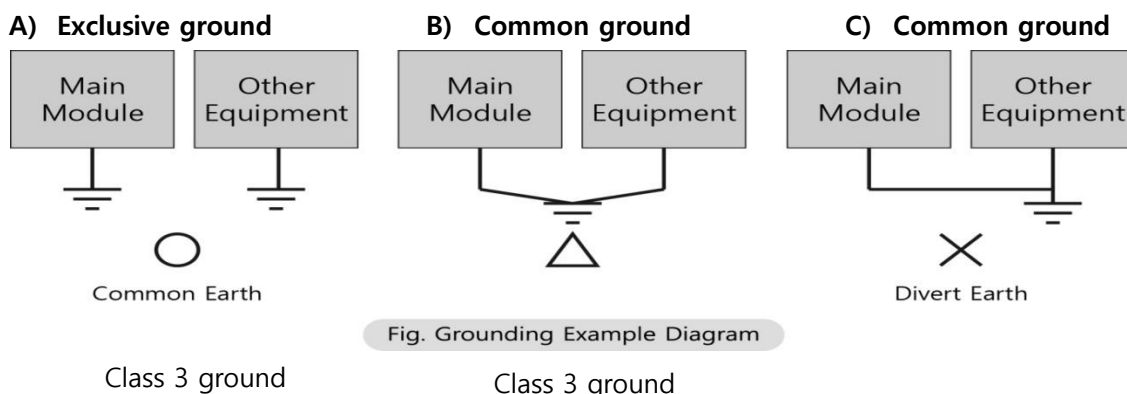

(4) Use the cable more than 4 mm^2 . Put the point of the ground near product and shorten Ground line.

Chapter 8. Maintenance Warning

8.1 Cleaning the Display

When the surface or frame of the display become dirty, spray the cleaning solution onto a soft cloth and wipe the device. Do not spray the cleaning solution directly onto the device.

8.2 Periodic Check Points

Check the followings periodically for best condition of the device

(1) Environment

- Is the operating temperature within the allowable range ($-10^{\circ}\text{C}\sim 50^{\circ}\text{C}$)?
- Is the operating humidity within the allowable range ($10\%\sim 80\%\text{RH}$)?
- Is the Surrounding pollution no corrosive gas?

(2) Power

Is the input voltage within the change range ($-15\%\sim +10\%$)?

(3) Related Items

- Check the guarantee duration of LCD Backlight by eye.
- Check the touch pad there is no damage, scratch or pollution by eye.

8.3 Problems with the Device Warning

- If there is a problem during operation, stop using it and contact the A/S department of M2I Corporation, which is indicated on the product label.
- Only the authorized worker from M2I Corporation can check and repair problems related to malfunction of the machine.
- If the problem cannot be solved at the installation site, the equipment can be collected and moved to M2I Corporation.
- The manufacturer, M2I Corporation, is not responsible for damage or malfunction of the equipment caused by the use conditions of the user beyond the installation and use standards described in the manual.

8.4 Setting System Recovery Mode

- If the system fails to boot normally due to a problem during operation, the built-in recovery function can be used to maintain the factory default state. Please note that the built-in project will be deleted when using the recovery mode.
- After opening the rear cover, you can adjust the setting switch.
Keep the "Normal" state when booting normally. If the system is recovering, turn off the power and set it to "Factory Reset".
- When the recovery is completed, the buzzer sounds, then turn off the power and reset to "Normal" state.

8.4.1 TOPRE0300QD / TOPRE0400WD

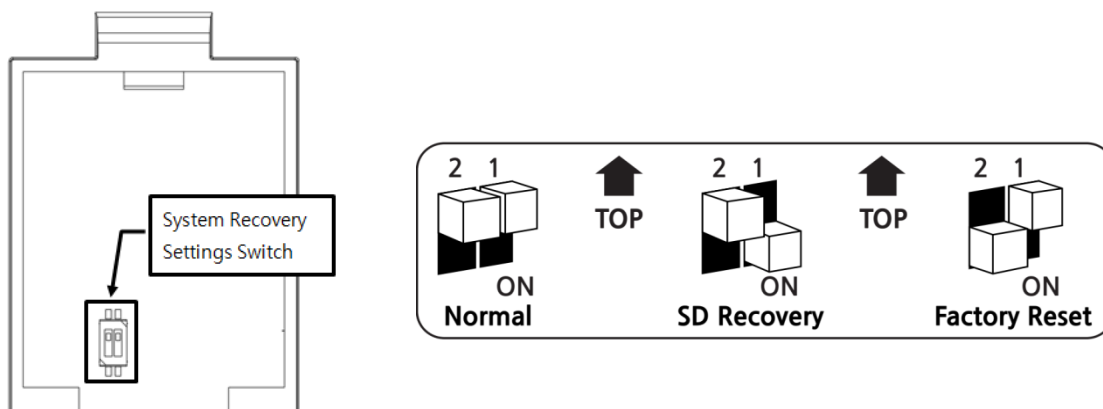

8.4.2 TOPRE0700WD

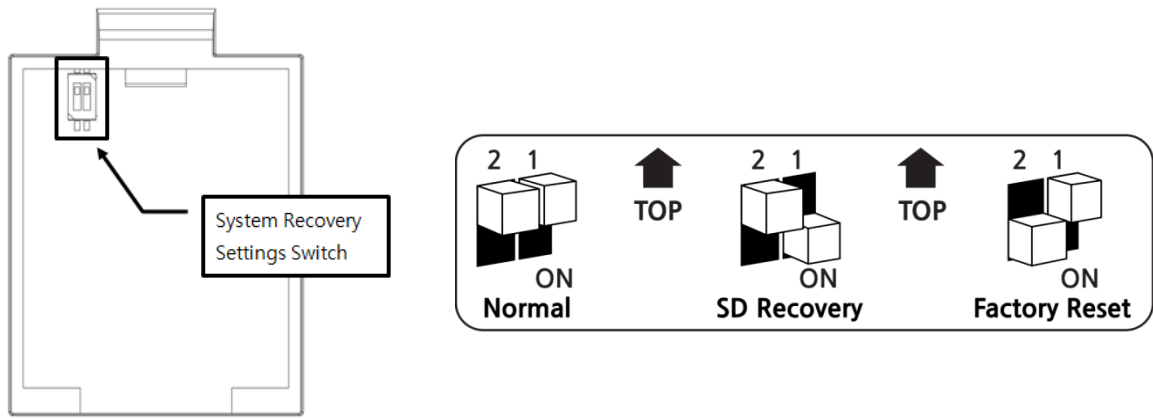

Chapter 9. Products and Warning Label Location

1. TOPRE0300QD / TOPRE0400WD

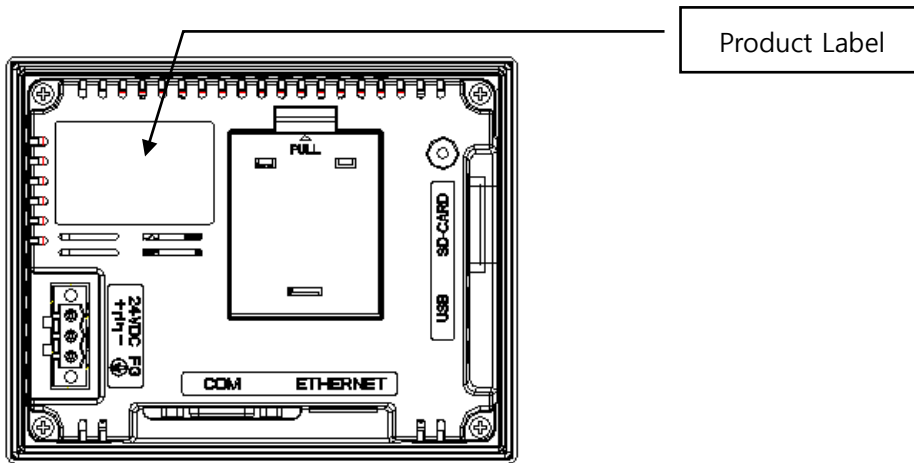

2. TOPRE0700WD

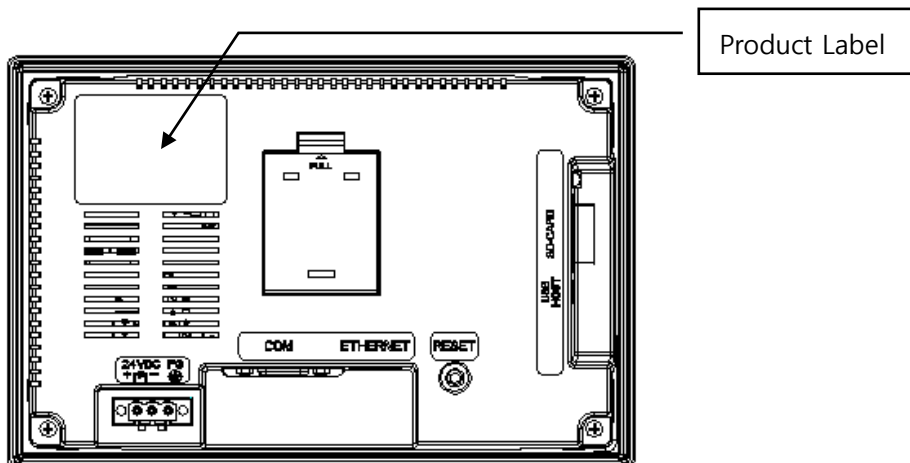

Chapter 10. Products Label



Manufacture (AS): M2I Corporation

11-35, Simin-daero 327beon-gil, Dongan-gu, Anyang-si, Gyeonggi-do 14055, Korea

Tel: 82-31-465-3366 www.m2i.co.kr

Product Name: Industrial HMI Touch Panel

Model Name: **TOPRE**□□ □□ □□

Operating Temp: -10 °C ≤ Ta ≤ +50 °C

Power Specifications: TOPRE03/04/07...24Vdc, 12W

KC Certificate No.:

Inside Cell: Model Name MS920SE(Rechargeable lithium Battery/No need for replacement)

Serial Number:

Copyright: M2I corporation 2020.11

www.m2i.co.kr