



## EMBEDDED HMI

## TOP SERIES

Caution: before operating the products, please be sure to read all related manuals

- Actual products color could be different from catalogs' product color
- All information contained in this catalog are subject to change without any notice
- The logo of Microsoft Windows and other products referenced here are registered trademarks of Microsoft Corporation in U.S and other countries

V 2.8E (240520)

### M2I Corporation

HEAD OFFICE | Address: 11-35, Simin-daero 327beon-gil, Dongan-gu, Anyang-si, Gyeonggi-do 14055, Republic of Korea

TEL | 82-31-465-3366

FAX | 82-31-465-3355

[www.m2i.co.kr](http://www.m2i.co.kr)

# SMART X HMI EMBEDDED HMI TOP SERIES



SMART X HMI

# THE BEGINNING OF CHANGE IS NOW

EMBEDDED HMI



## Contents

### COMPANY INTRODUCTION\_4P

**01** | Greetings/Applied Field/History

### TOP SERIES INTRODUCTION\_6P

**02** | TOPR/TOPRX/TOPRW/TOPRW-IO  
TOPRE/TOPRH/TOPRP

### SOFTWARE INTRODUCTION\_8P

**03** | TOP Design Studio

### UTILIZATION OF TOP\_12P

**04** | Use of Smart TOP in Industrial Field

### HARDWARE INTRODUCTION\_16P

**05** | Solid and High-Performance Hardware  
Connectable Devices by Serial/Ethernet Port

### TOPR SERIES\_20P

**06** | Detachable Aluminum Body with Multimedia Functions  
Premium/Standard/ATEX Model

### TOPRX SERIES\_26P

**07** | The Series Developed TOPR's Function from  
XTOP Products  
Normal/EX Model

### TOPRW SERIES\_30P

**08** | With a Wider Screen  
TOPRW Series

### TOPRW-IO SERIES\_34P

**09** | Integrated I/O HMI  
with Flexible Composition and Control

### TOPRE SERIES\_38P

**10** | Compact Size, Light and Convenient  
TOPRE Series

### TOPRH SERIES\_42P

**11** | Wireless/Wired Handy Type  
with Ergonomic Designed Hand Grip  
TOPRH Series

### TOPRP SERIES\_50P

**12** | Miniaturized New Form Factor,  
Smaller and Simple TOPRP Series

### MDP SERIES\_54P

**13** | 2 Channel KVM Touch Monitor  
with Capacitive Touch and FHD LCD

### AGENCY INTRODUCTION\_58P

**14** | Introduction of Overseas/  
Domestic Dealerships



## Greetings

HMI Specialized Company

**M2I Corporation was established in April 1999 for manufacturing industrial HMI, and get strong visions of global HMI specialized company in industrial monitoring/control ling territory**

We do the roll to sense all information of industrial field and signals of devices, and connect human and machine. Also we support not only manual operation, but also smart system(Automatic monitor/Control).

Continuous R&D and technical service development were focused all the time as dramatic changes of industrial structure. And M2I tries constantly for brand identity and quality development by products that customer needs and make wide range of product line-up







M2I Corporation cooperates plenteous customers with knowledge and know-how in industrial automation field. Aiming to be the global leader of smart factory and industrial IoT, M2I Corporation will do the best to improve the reliability and productivity by revolutionary product development and service.

M2I Corporation

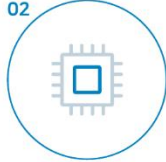
## Applied Field

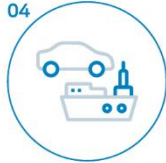
### Optimized Product for Smart Factory, Represented as Industry 4.0

M2I's Smart HMI is surpassing traditional HMI products for Factory Automation, and having connectivity for various devices, flexible functionality, stability and security. With various versatile, it can be used in Smart Factory and other various fields, and it is adopted not only in high-technology industry like Semiconductor, Display, but also in Growing/Normal industry like Automobile, Mobile Device, Secondary Cell, and Pharmacy/Bio.

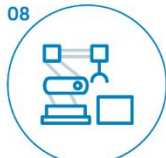
- |  |   |
|--|---|
| <p>01  <b>Display/Mobile Phone</b><br/>Logistics</p>  | <p>02  <b>Semiconductor/Electronics</b><br/>Gas cabinet, VMB, Chiller, Loader/Unloader, Scrubber Lead frame, Laser marker, Chamber</p> |
| <p>03  <b>Chemical/Steel</b><br/>Pharmacy, Plastic, Cosmetics, Chemical, Steel manufacture</p>    | <p>04  <b>Automobile/Shipbuilding</b><br/>Painting, Welding, Pressing, Assmebly</p>  |
| <p>05  <b>Food/Pharmacy</b><br/>Ramen, Soup, Snack, Ice cream, Milk, Rice, Packaging, Storage</p> | <p>06  <b>Secondary Cell/Solar</b><br/>Oil refining, Battery, Power generation, Water resources</p>                                    |
| <p>07  <b>Textile/Packaging</b><br/>Dyeing, Print, Dry cleaning, Knitting, Rotary machine</p>     | <p>08  <b>Automated/Logistics</b><br/>OHCV, OHT, Lifter, OHS, AMR, AGV, Stacker Crane</p>  |

## History

HMI Specialized Company

**M2I Corporation will do the best to improve the reliability and productivity by revolutionary product development and service.**



### 2016 - Present Customized Smart Factory Solution

**Relocation of New M2I Building  
Smart Factory Solution Business Start and  
Obtaining New Projects' Orders**  
Launching TOP-PCVIEW Series, Designated in  
Semiconductor and Automobile Industry  
**Launching TOPRW and TOPRE Series**  
The Highest Sales Record as 60,000 Units  
**Launching TOP-VIEW(SCADA S/W)  
and TOP-PCVIEW(Panel PC)**

### 2011 - 2015 Endless R&D and Effort

**Launching TOPRX and TOPRH Wired/Wireless Series**  
ATEX/KCS/NEPSI Certificates for XTOP Series Acquired  
**Launching TOPR Series**  
Launching XTOP Wide Series



### 2001 - 2010 The Automation in Anywhere

Launching HTOP Handy Type Wired/Wireless Series  
**Opening Regional Office in Daegu**  
Launching XTOP Series  
Selected to INNO-BIZ Company  
UL/CE/FCC Certificates Acquired



### 1999 - 2000 The beginning of M2I

Venture Company Certificates Acquired  
Launching TOP Series(The First Industrial HMI in Korea)  
**M2I Corporation Established**





## TOP Series Introduction

## Product Line-Up Satisfying Customers' Various Needs

**TOPR**

Detachable Aluminum Body with Multimedia Functions

**Premium/Standard/ATEX Model**

SERIAL 3 PORTS | ETHERNET 2 CHANNEL | USB HOST 2 PORTS | USB OTG | SD CARD  
OPTION MODULE | HDMI OUT | CAMERA | AUDIO OUT | VIDEO IN

\* Multimedia functions are supported only in premium model



EMBEDDED HMI

**TOPRE**

Compact Size, Light and Convenient

**TOPRE Series**

SERIAL 1 PORT | ETHERNET 1 CHANNEL | USB OTG | SD CARD



EMBEDDED HMI

**TOPRX**

The Series Developed TOPR's Function from XTOP Products

**Normal/EX Model**

SERIAL 3(2) PORTS | ETHERNET 2(1) CHANNEL | USB HOST | USB OTG | SD CARD

\* 15", 12", 10", 8", 5" please check the number of ports by each model



EMBEDDED HMI

**TOPRH**

Handy Type with Ergonomic Designed Hand Grip

**TOPRH Wired/Wireless Series**

**Wired** SERIAL 2 PORTS | ETHERNET 1 CHANNEL | USB HOST 2 PORTS | SD CARD

**Wireless** WIFI | USB HOST 2 PORTS | USB OTG | SD CARD



EMBEDDED HMI

**TOPRW | TOPRW-IO**

With a Wider Screen

**TOPRW/TOPRW-IO Series**

SERIAL 2 PORTS | ETHERNET 1 CHANNEL | USB HOST | USB OTG | SD CARD

\* USB HOST functions is supported only in 10" and 7"



EMBEDDED HMI

**TOPRP | MDP**

Miniaturized New Form Factor, Smaller and Simple

**TOPRP Series/2Ch KVM Touch Monitor**

SERIAL 2 PORTS | ETHERNET 2 CHANNEL | USB HOST 2 PORTS | USB OTG  
SD CARD | HDMI OUT



BOX HMI/2CH KVM TOUCH MONITOR



# TOP Design Studio Software

Easier and More Diverse

The software which supports TOPR, TOPRX, TOPRW, TOPRE, TOPRH, TOPRP, TOP-PCVIEW(SCADA), you can download in **M2I website(www.m2i.co.kr/eng)** for free.

## Combination of PC BASED HMI and EMBEDDED HMI

Mutual convert between PC BASED HMI(SCADA, TOP-PCVIEW series) and EMBEDDED HMI(TOPR/TOPRX/TOPRW/TOPRE/TOPRH series) is possible. So program is efficiently used. This make the person who is familiar with EMBEDDED HMI program(TOP Design Studio) easy to use PC BASED HMI(SCADA) program without any training procedure.

To change the project, select [Project] - [Property] - [Change HMI] function in TOP Design Studio.



- 01 LANGUAGE
- 02 DYNAMIC RIBBON MENU

### LANGUAGE

This software supports korean/english/chinese(Simplified)/japanese. You can select the language in [VIEW-Language] menu in software.

- 03-1 DOCKING WINDOW
- 03-2 DOCKING WINDOW

### PROJECT PROPERTY WINDOW

Helping the project/screen/resource to be easier and systemized management.

- 03-3 DOCKING WINDOW
- 03-4 DOCKING WINDOW

### PROPERTY WINDOW

Showing the property of screen/object and editing them is possible. Same kind of object can be edited by group in same time.

### DYNAMIC RIBBON MENU

Menu-Toolbar united ribbon UI, easy to use by big icon.

### OBJECT LIST WINDOW

The object registered on screen is shown as table format.

### USER LIBRARY WINDOW

Supporting the screen/parts designed by objects.

## 01. Automatic Resizing Function for Model Change

If you change the TOP model which has different resolution, all registered objects in screens will automatically resize by new model's resolution.



## 02. Vector Image Library

TOP supports vector image library(SVG format) with 16M full color. Vector image can display clear view regardless of size change.

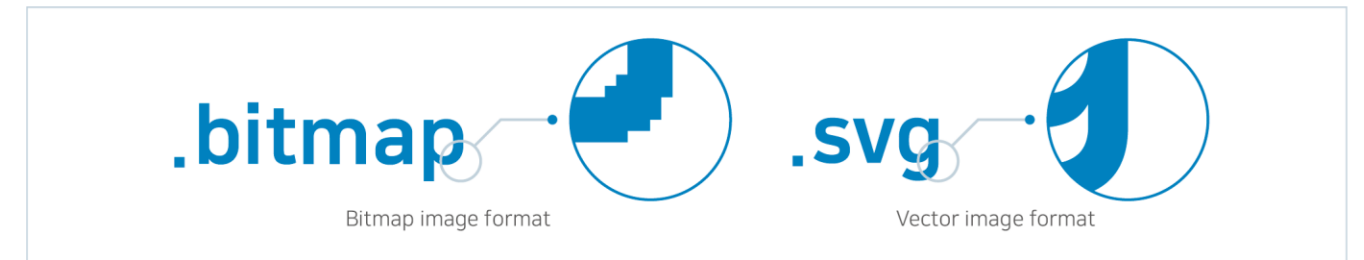

## 03. User Library Window Sample

We supply the sample of screens and objects which customers can use for their own project.

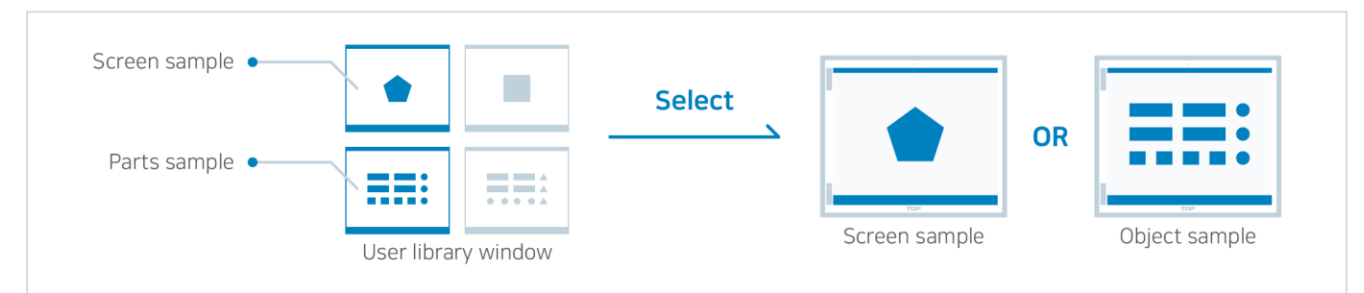

## 04. Off-Line/On-Line Simulation

Off-line simulation is a test operation in PC without the control unit, and on-line simulation is a test operation in PC connected to control unit like PLC. This on-line simulation has 2 hours trial mode. The operation of TOP and PC simulation is same because they are same program.



## TOP Design Studio Software

Easier and More Diverse

### 05. Flexible and Easy Programming by [Effect/Action] Function of Object

[Effect/Action] function is supported regardless any shape or type of object. If a set [Condition] meets, [Effect] or [Action] already set operates. Animated effect and other many operation can be set in object.



**Condition(AND/OR)**  
Event(Touch) + Bit data + Word data + String data + Time/Schedule + Interval

**Effect**  
Hide + Disable + Reverse + Blink + Shape change + Image change + Width/Height change + Move + Rotate

**Action**  
Bit data + Word data + String data + Script + Key + Special function

### 06. Faster and More Accurate Analysis by Variable Graph Format

Beyond one or two, 3 dimensional graph shows the data quickly.

  
Chart graph

  
Pi graph

  
Donut graph

  
Meta graph

  
Bar graph

  
Trend graph

  
3D graph





\* 3D graph is supported in TOP Design Studio v2.0

### 07. Global Alarm Scroll/Action for Occurred Alarm

Alarm list can be shown as table format or scroll format. [Global alarm scroll] function displays the contents of occurred Alarm by scroll format moving by 1 letter. An operator can check the alarms in any screens. The action for this occurred alarm, supports showing image/text/PDF file and sound effect. Also, operating set action or saving a certain address data maximum 10ea.

  
Global alarm scroll display

Action

 OR 
  OR 
  OR 
 

### 08. Schedule Function Address Data

Each schedule(Year/Month/Day/Hour/Minute/Second) can be set as PLC's address, so data can be edited during operation. [\* Project menu > Schedule > Schedule table dialog]

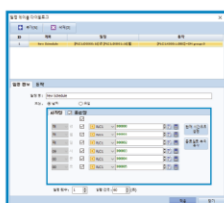

Step. 01

Set start and end schedule as PLC address

➤

Step. 02

Set the count of operation and interval

➤

Step. 03

Set an action

### 09. Text/Image Automatic Copy

If text data outside of TDS is copied and pasted in TDS, a [Text object] is created automatically. If image data outside of TDS is copied [Image object] is created automatically.

  
Memo

  
Paint

➔

  
TOP Design Studio

Automatically made text/image object

### 10. Multi-Layer System of Object

Object can be layered and set by top/bottom order. Putting layered object on other object and set animated effect is available.

  
Object overlap(Ordering)

  
Group object

  
Move

  
Blink



  
Rotation

### 11. Table Object

Easy registration without any drawing process of table. Text/Image/Numeric/String/Clock/Lamp objects can be set in table property dialog.

  
Table object

➔

	ABC	ABC
ABC		123
ABC		123

Object setting by each cell

### 12. Easy and Powerful Programming by JAVA script

As the powerful functions of JAVA script, the most common used one, not only a simple command but also programming language can be set easily with samples.

  
JAVA script

➔

  
TOP

Coding

```

var addt1 = (@PLC1.R00000:16.DEC);
if addt1 > 0 {
  @PLC1.R00001:16.DEC = 0;
}
if (@PLC1.R00000:16.DEC == 0) {
  @PLC1.R00001:16.DEC = 100;
}
else {
  @PLC1.R00000:16.DEC = @PLC1.R00001:16.DEC;
}
for(i=1; i<=100; i=i+1) {
  if(i=10) continue;
  @PLC1.R00000:16.DEC = i+4
}
            
```

```

var addt1 = (@PLC1.R00000:16.DEC);
if addt1 > 0 {
  @PLC1.R00001:16.DEC = 0;
}
if (@PLC1.R00000:16.DEC == 0) {
  @PLC1.R00001:16.DEC = 100;
}
else {
  @PLC1.R00000:16.DEC = @PLC1.R00001:16.DEC;
}
for(i=1; i<=100; i=i+1) {
  if(i=10) continue;
  @PLC1.R00000:16.DEC = i+4
}
            
```



## Use of Smart TOP in Industrial Field

More Convenient and Safer

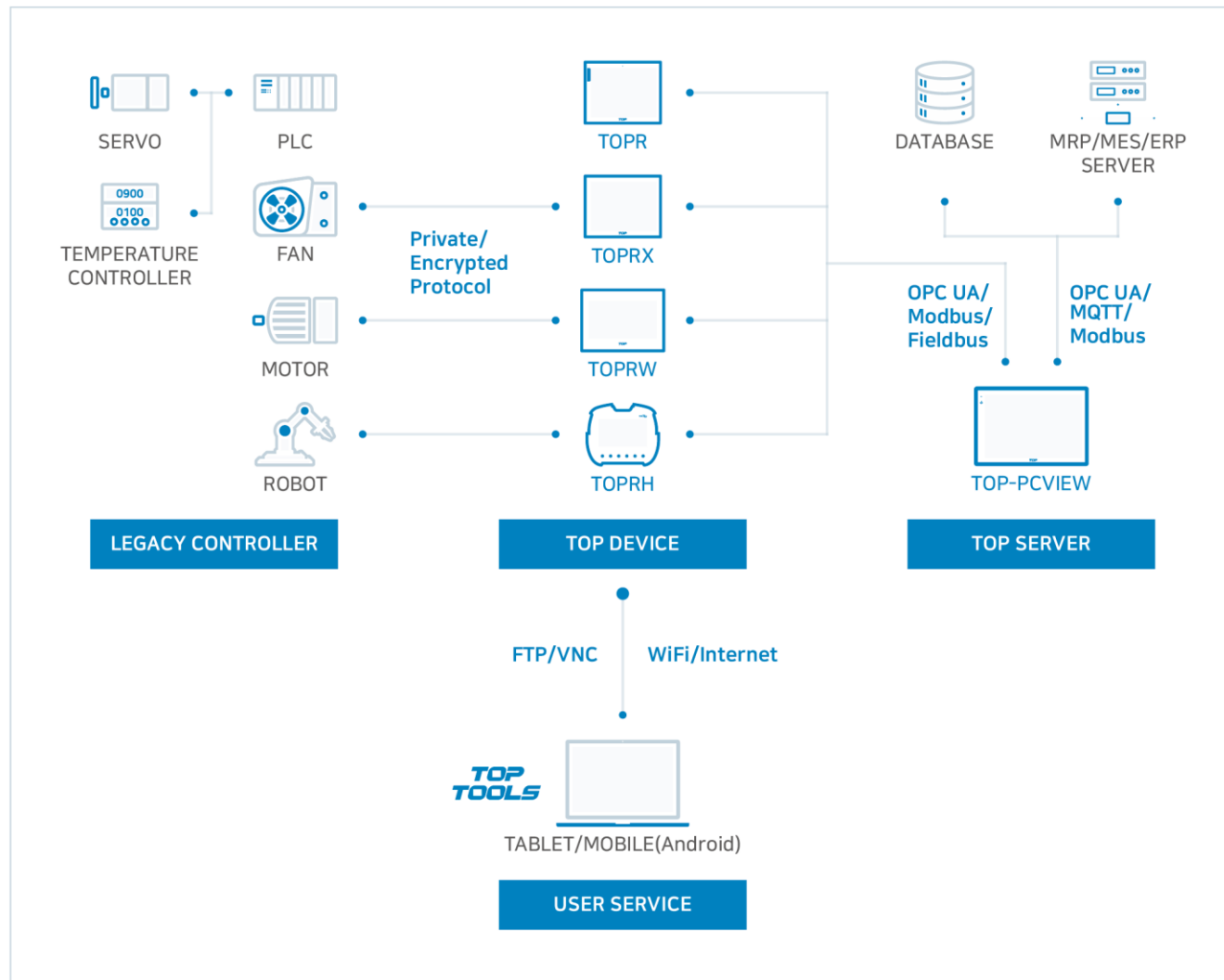

### 01. VNC(Virtual Network Computing)/FTP(File Transfer Protocol)

The screen of TOP in factory can be monitored and controlled by remote PC, tablet, mobile device, and other TOP by VNC. Also file transferring is possible by FTP.



### 02. OPC UA(Open Platform Communications Unified Architecture) Protocol Supports

OPC UA is a future-oriented and expandable architecture. This makes PCVIEW(PC BASED HMI) gather and manage data stable.

### 03. E-mail, SMS Sending in Factory Field

E-mail and SMS set in program can be sent by field's condition. Manager or customer can receive the situation immediately by E-mail and SMS.

### 04. Multi Screen

A single screen can show several other screens with 'Screen call object'. Monitoring a number of screens is possible, and screen change will be done when this small screen call object is touched.

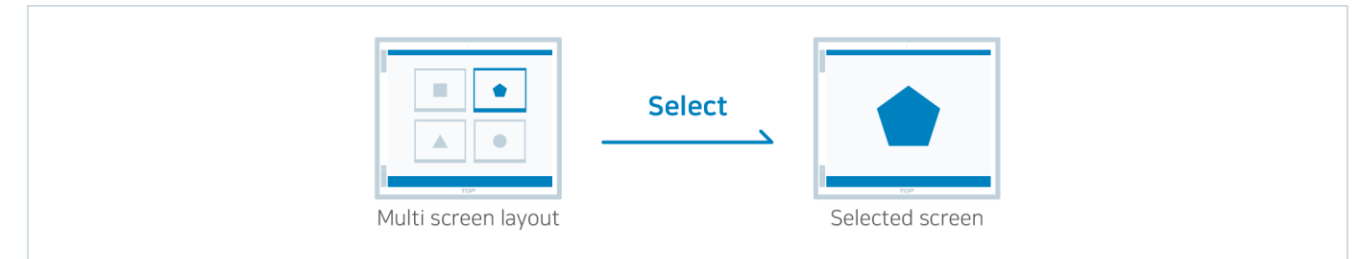

### 05. Using Big Screen with HDMI Out

Set a screen as multi screen, and show this to big monitor or TV by HDMI. HDMI screen can show individual screen as HDMI dual mode.

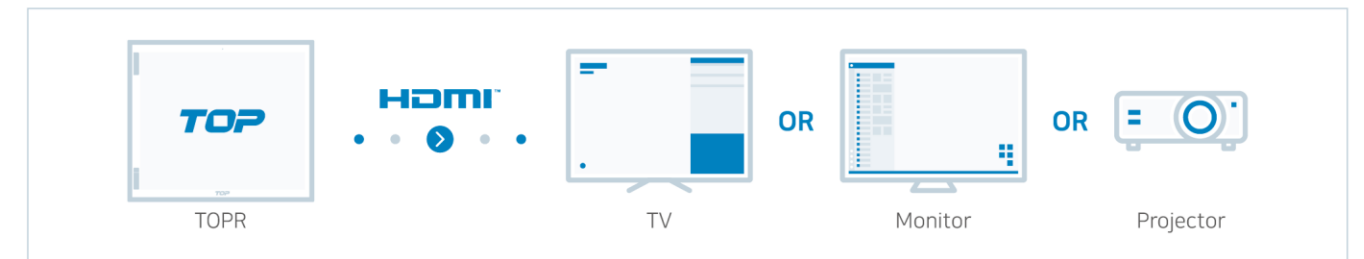

### 06. Thermal/IP/Video/Integrated Camera

TOPR premium model has an integrated camera in front side, and a video port which can connect a video camera. Thermal and IP camera can be connected to ethernet port, and USB camera is also connectable. Operating with video and recording is possible. Also, making safer industrial environment is possible using this function in anti-fire or security area.

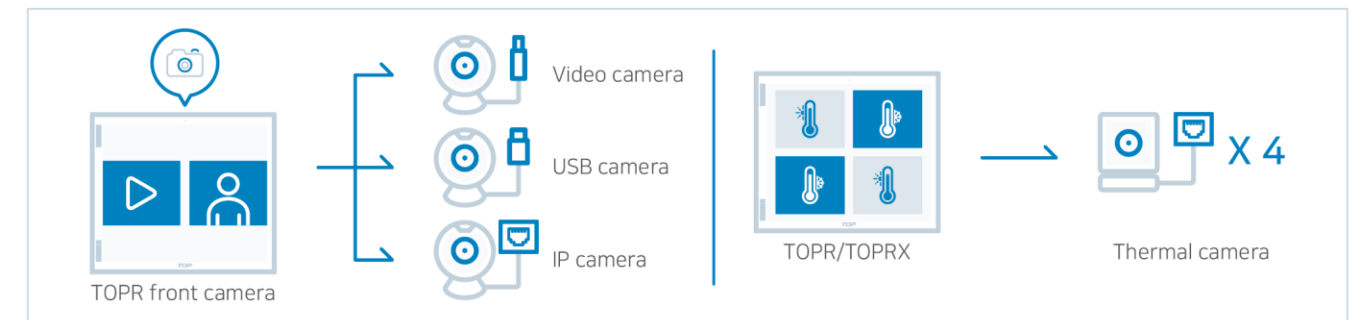

### 07. Immediate Graph Display of Data in SD Card

Sampling a data in SD card and showing it in record graph can make the analysis faster.

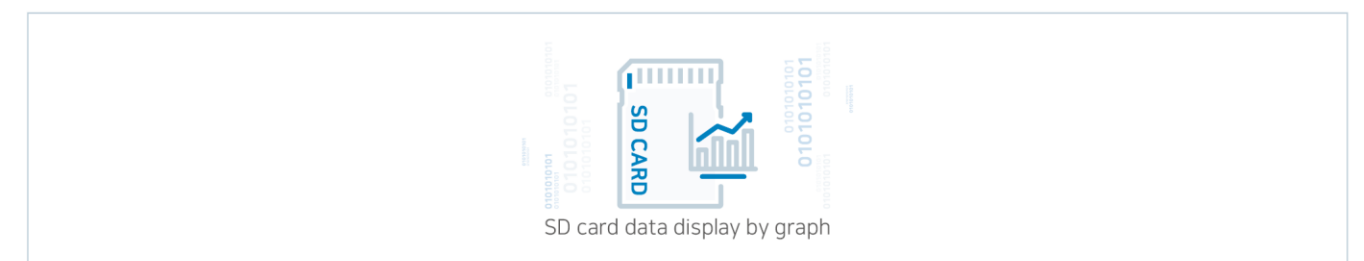

## Use of Smart TOP in Industrial Field

More Convenient and Safer

### 08. Close Security Management and Convenient Log-in

TOP can set 16 levels of password to be safe security management. Log-in methods are input the password directly by keyboard, or using QR code, RFID tag. External reading device is needed for each method of log-in. Additionally, security log function is able to record the log-in and log-out, or save the video data of log-in spot by capture function.

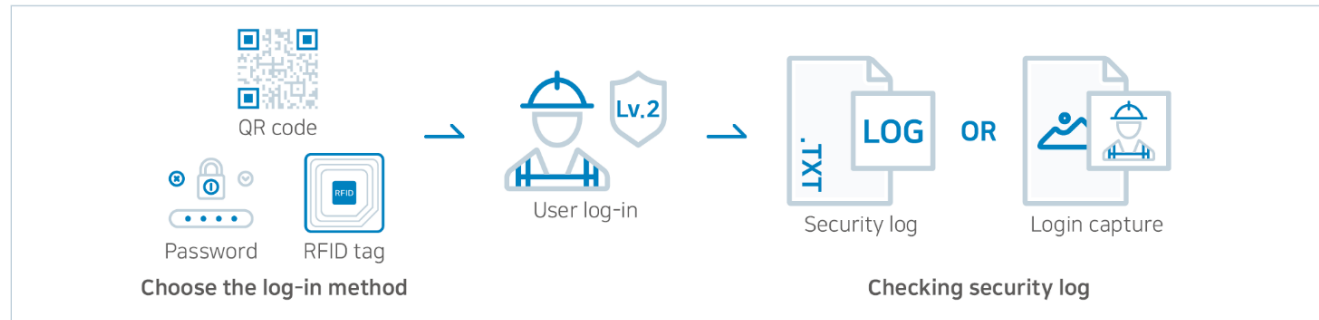

### 09. FDA 21CFR Part 11

Operator authorization, tracking the log of monitoring/control, managing DB and PDF file.

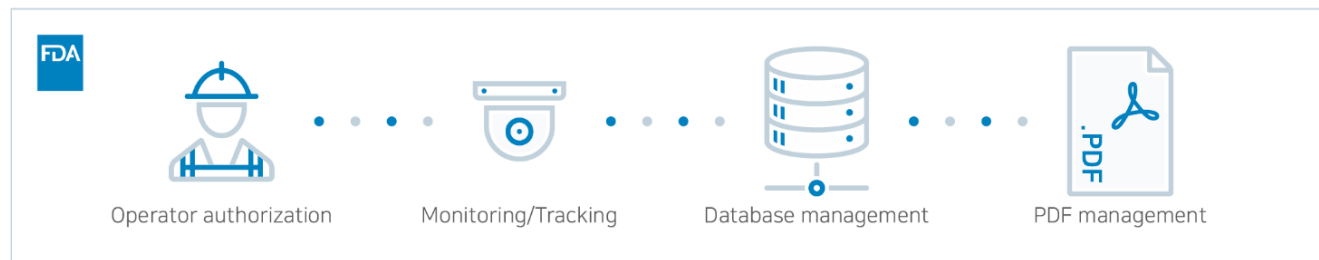

### 10. HSMS SECS GEM Protocol for Semiconductor Industry

Communication for Variable/Alarm/Report/Event/Item/Message/Host command and remote command/limit monitoring

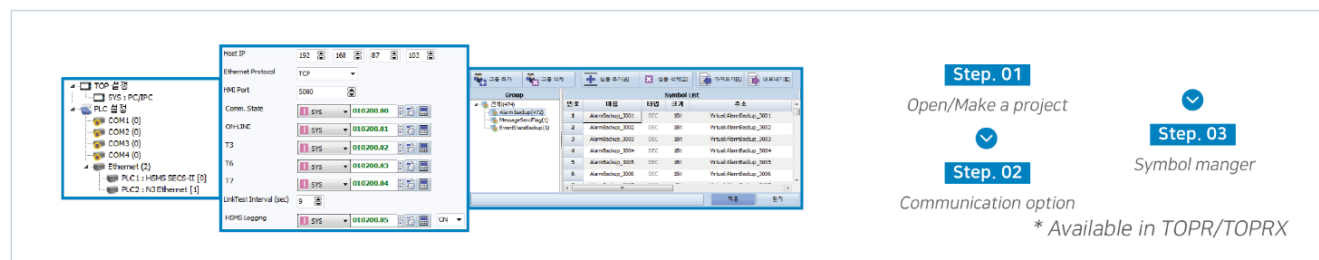

### 11. Memo Write/Read for Operator

Memo function with text/drawing mode on the spot is possible. Saved memo can be checked by a selected operator.

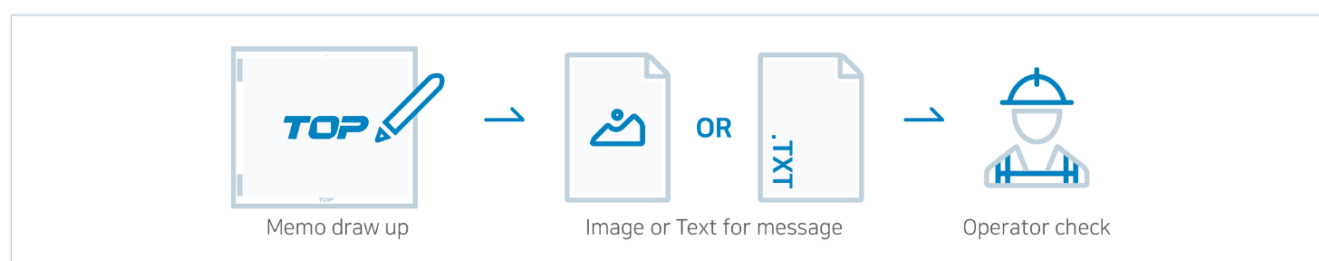

### 12. Log/Recipe Data Monitoring, Always On The Spot

There is Logviewer/Recipe menu in Top side menu, showed when you drag from upper outside to inside. [Logviewer] menu is a table format viewer for log file even in SD card. [Recipe editor] menu is also table format for recipe data in TOP's memory and editable of item names or data. So, additional object on the screen is not needed to check log/recipe data on the spot anytime.

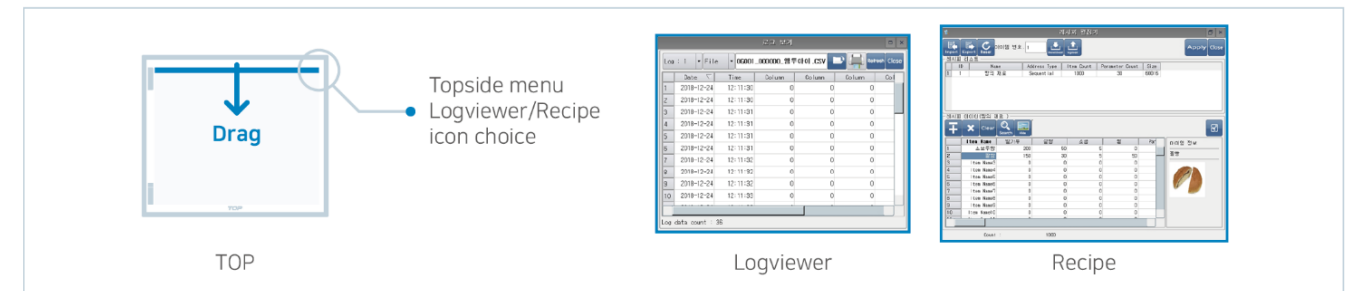

### 13. File Checking On The Spot, with Image/Text/PDF viewer

Screen captured images, text files like system log, and manuals in PDF format can be monitored immediately on TOP without transfer to Laptop or PC.

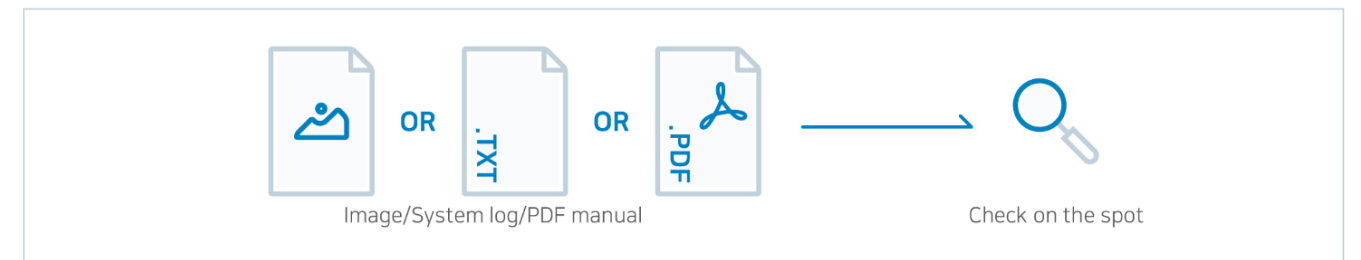

### 14. Project Change without PC, On The Spot

Using project browser menu, project launch file(HBZ) in USB memory/SD card/TOP internal memory can be selected. When the [OK] button is pushed, project can be changed on the spot.



### 15. Wider Use by Zoom Screen Function

Virtual working space, which is bigger than product's resolution, is supported.

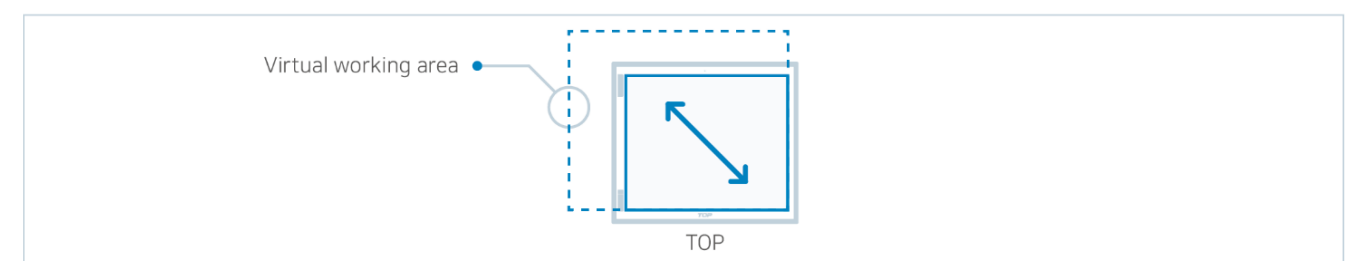



## Solid and High-Performance Hardware

Smarter

TOPR,RX,RW,RE,RH support QUAD CORE CPU, 16M FULL COLOR

**QUAD CORE CPU** Extraordinary speed **16M FULL COLOR** Clean and detail display with bright and clear touch screen

## Convenient TOP Menu

Top-side menu bar shows by drawing down from top side of screen. When EXIT button is pushed, screen is changed to menu screen. They are organized with Icons, and supporting korean/english. This menu support variable information and convenient functions.

### Top-side menu



### Menu screen



Menu screen with icon UI like PC, which is more familiar. (Supporting VNC viewer, FTP, Project browser, File browser, Screen shot, Control panel, Information, etc)

Supplying various functions in menu as, Communication Status Checking/Touch Sensing Test and Calibration/Data Move/Setting Changes/Information Display. Menu Screen can be protected and managed by Admin Password functions.

## Certificates



## Representative Interfaces

### USB OTG

Convertible port between 'Transmitter mode' to transfer the program and 'Host mode' to connect USB devices like memory, barcode reader, or camera.

### SD Card

Saving data like Log/Alarm/Recipe, Up/Downloading files like Project/Image/Video/Text, and Recovery disk.

### Ethernet Port

Connect with PLC, PC, camera, barcode reader, etc.

### Rear USB HOST Port

Connect with barcode reader, camera, memory, etc.

### Serial Port

Connect with PLC, servo, temp controller, barcode reader, etc.

This description introduces common ports for all series M2I supports, so each model's available port can be different. Please check exact port configuration in specifications and draws of each model.

## Connectable Devices by Serial/Ethernet Port

Manufacturer	Series	CPU Type	RS-232C/422/485	Ethernet	
<b>PLC</b>					
MITSUBISHI Electronic Corporation	MELSEC-Q	Q□□/00J/□□H/□□UDH/□□UDEH	●	●	
	MELSEC IQ-R	R□□	●	●	
	MELSEC-FX	FX0/1/2/1S/1N/2N/2NC/3U/3UC/3G/10/20GM	●	●	
	MELSEC IQ-F	5U	●	●	
	MELSEC-A	A1N/2N/3N	●	●	
		A1S(H)/2S(H)/AOJ2(H)	●	●	
		A2A/3A/2A-S1	●	●	
		A2U/3U/4U/2USH	●	●	
	OMRON Industrial Automation	SYSMAC CJ2	CJ2H	●	●
		SYSMAC CJ1	CJ1G/1M	●	●
SYSMAC CS1		CS1G/H	●	●	
NJ		NJ□□□	●	●	
NX		NX□□□	●	●	
SYSMAC CP		CP1L/1H	●	●	
SYSMAC C		C50/120/200/500/1000	●	●	
		CQM1/1H	●	●	
		CPM1/2A/2C	●	●	
		Mobile Robot LD	LD60/LD90	●	●
LS Industrial Systems	XGT	XGI/XGR/XEC/XMC	●	●	
	XGB	XGK/XBM/XBC	●	●	
	GLOFA-GM	GM1/2/3/4/6/7	●	●	
	Master-K	80/120/200/300/1000S 10S1/10/30/60/100S 60/200H 500(H)/1000	●	●	
SIEMENS AG.	SIMATIC S7-1200	All models	●	●	
	SIMATIC S7-1500	All models	●	●	
	SIMATIC S7-400	All models	●	●	
	SIMATIC S7-300	All models	●	●	
	SIMATIC S7-200	All models	●	●	
	LOGO!	OBA8	●	●	
	SIMATIC S5	90/95/100/115/135/155U	●	●	
	ControlLogix	1756	●	●	
	CompactLogix	1768/1769	●	●	
	MicroLogix	1000/1200/1500 system	●	●	
Rockwell Automation(Allen Bradely)	SLC500	SLC5/03/04/05	●	●	
	PLC-5	PLC5/11/20/30/40/40L/60/60L	●	●	
	MODBUS	All models	●	●	
GE Fanuc Intelligent Platforms	MODBUS/TCP	All models	●	●	
	Series 90-30 PLC	IC693C□□□□□	●	●	
	Series 90-70 PLC	IC697C□□□□□	●	●	
Schneider Electric Industries	Micro	TSX37 All models	●	●	
	Premium	TSX/TPMX P57 All models	●	●	
	Twido	TWD LCAA/LMDA All models	●	●	
	Quantum	140 CPU All models	●	●	
PANASONIC Electric Works	Momentum	171 CCS/CCC All models	●	●	
	M340	M340	●	●	
	FP	FP2(SH)/X/Σ/0/e/M/10S(H)/3/1,FP-X,FP7	●	●	
YASKAWA Electric Corporation	PROGIC-8	PROGIC-8	●	●	
	MP900/2000/3000	MP920/930/2200/2300	●	●	
	Control Pack	CP-9200SH	●	●	
YOKOGAWA Electric Corporation	SR100	SR100	●	●	
	FA-M3	F3SP□□-□N/H/S	●	●	
FUJI Electric	Micrex-SX	SPH□□□	●	●	
	Micrex-F	F, F□□(S/H), F1□□(S/H), F200	●	●	
KEYENCE Corporation	KV	KV-700/1000/3000/5000/7000/8000	●	●	
	Nano	KV-10/24	●	●	
KOYO Electronic Industries	DL-205/305/405	Nano	●	●	
	FBs	D2 240/330/430	●	●	
FATEK Automation Corporation	FBe	FBs-□□MA/MC/MN	●	●	
	FBn	FBe-□□MA/MC	●	●	
	Alpha	FBn-□□MCT	●	●	
RS Automation	Plus	N7/NX(70/700/750/CCU)	●	●	
	SPC	NX7/NX Plus(70P/700P/CCU+)	●	●	
	N7_NX	SPC-10/100/120S/300	●	●	
	X8	70./700/750	●	●	
KDT Systems	CM1	All models	●	●	
	CM2	XP/CP	●	●	
	CM3	BP	●	●	
TOSHIBA	T / V	S/SB	●	●	
	Tiny PLC	All models	●	●	
Comfile Technology	Qubloc	TCP-3X/9X	●	●	
	HIDIC-H	All models	●	●	
Hitachi Industrial Equipment Systems		EH-150	●	●	

Manufacturer	Series	CPU Type	RS-232C/422/485	Ethernet
		Micro EH	●	
Delta	DVP	DVP series	●	
VIGOR Electric Corporation	M/VB/VH	M series / VB series / VH series	●	
HONEYWELL	HC900	HC900	●	●
IDEC Corporation	MicroSmart	FC3/FC4A	●	
HAWE Hydraulik	PLVC	PLVC	●	
	ACON	ACON-CB/CGB/C/CA/CG/SE/CY	●	
	PCON	PCON-CB/CGB/CFB/CGFB/CA/CF/CG/CF/SE/CY	●	
IAI Corporation	SCON	SCON-CB/CGB/CB-F/CA/CAL/CGAL/C	●	
	RCP6	RCP6S	●	
	ERC	ERC2/3	●	
	XSEL	XSEL-J/K/JX/KX/P/Q/PX/QX	●	
BECKHOFF	TwinCAT	TwinCAT supporting ADS/AMS		●
Azbil Corporation	SDC, DCP, DMC, CMC	SDC, DCP, DMC, CMC	●	
CODESYS	CODESYS V2		●	●
	CODESYS V3			●
B&R Automation	X20	X20	●	
JTEKT	TOYOPUC	PC10G, PC3J/PC3JX, Plus	●	●
<b>Temperature Controller</b>				
	CB	CB100/400/500/700/900	●	
	FB900/400	All models	●	
	HA900/400	All models	●	
	MA900/901	All models	●	
RKC Instrument	SRV	V-TIO-A/V-TIO-C	●	
	SRX	X-TIO-A	●	
	SA200/100	SA100	●	
	SR Mini HG	H-PCP-A/H-PCP-J	●	
	SRZ	Z-TIO/DIO/CT/COM	●	
	NP200/100	All models	●	
HanyoungNux	NX, PX	NX9/7/3/2, PX9/7	●	
	RT	RT9	●	
	UX100	UX100	●	
	NOVA500	SD5□□/SL5□□/SP5□□/ST5□□	●	
SamwonTech	NOVA300	SD3□□/SS3□□/ST3□□	●	
	SP790	SP7□□	●	
YOKOGAWA Electric Corporation	UT/UP/UM	UT(JUP/UM/UD)3/4/5/7/10□□	●	
	DB	DB1/DB2 All models	●	
	KP	KP1/2/3 All models	●	
CHINO Corporation	LT	LT23/3/4/830 All models	●	
	JU	JU All models	●	
	JW	JW All models	●	
Human Automation	TSD	V5-SC1T	●	
On Off Sstern	HSD	NEOS-HSD	●	
TOHO	TTM	TTM-00□	●	
	T50	T50	●	
TemcoLine	N50	N50	●	
	M74	M74	●	
<b>Inverter</b>				
LS Industrial Systems	Starvert Inverter	SV-IS7/G5A/P5A/C5/V5/G5/S5/H/V/S3	●	
Huropec	HC	HC	●	
FUJI Electric Systems	Inverter	FRN□□□□11S-□	●	
<b>Weight Indicator</b>				
AND	AD	AD4326/4327/4328/4329	●	
	CI/NT	CI/NT	●	
CAS	XB	XB	●	
	CI-1580A	CI-1580A	●	
BONGSHIN	BS	BS	●	
SEWHA CNM	SI	SI-4□□□	●	
Shinhan Electronics	SH	SH-5100	●	
MINEBEA	CSD	CSD-912/912B-EX/903/904-EX/891B/815B/701B/709/819C/401	●	
<b>Barcode Reader</b>				
General Barcode Reader	Barcode	USB/RS-232C	●	
KEYENCE Corporation	Barcode	BL-1300 Sereis	●	
OMRON Industrial Automation	Barcode	MicroHAWK Barcode Reader		●
Cognex Corporation	Barcode	DataMan Series		●
OPTION	Barcode	NLV		●
KEYENCE Corporation	Barcode	SR Series(SR1000/SR1000W/SR-X300/SR-X300W)	●	●
<b>RFID Reader</b>				
OMRON Industrial Automation	RFID	V680	●	
	RFID	V680S		●
LS Industrial Systems	RFID	XCODE-1306/1307	●	
IDRO	RFID	900F		●
CEYON Technology	RFID	TRA5		●
	RFID	CRE1356		●
SICK AG.	RFID	RFH6xx	●	
SYSTEMK	RFID	HFR-2AM/4AM		●

Manufacturer	Series	CPU Type	RS-232C/422/485	Ethernet
<b>Motion Controller</b>				
	iMS-J	iMS-J	●	
DST ROBOT(former DONGBU)	iM-Σ	iM-Σ2/3/4/5/6/7/8	●	
	iM-U	iM-U	●	●
	DTR	DTR2/3/4	●	
ROBOSTAR	Newro	RCS6000/RCM	●	
	MCU	MCU-MA/MP/XA/XP	●	
	MCU2	MCU-MA2/MP2/XA2/XP2	●	
EMOTIONTEK	MCS	MCS-80A4/P4/A8/P8	●	
	MCSH	MCSH-1/2/16/80	●	
	MCST	MCST-16		●
OMRON Industrial Automation	Compositioner	3F88L-160/162	●	
	Ezi-Servo	Plus-R	●	
FASTECH		Plus-E		●
Gidding & Lewis	MMC	MMC	●	●
TOSHIBA	COMPO	COMPO ARM ROBOT	●	
Lenze	L-Force	L-Force servo		●
Delta-Tau	PMAC	PMAC	●	●
MISUMI	EXRS-C1	EXRS-C1	●	
CSCAM	GX	All models	●	
<b>Servo</b>				
MITSUBISHI Electronic Corporation	MELSERVO	MR-J2S/M, MR-J3, MR-J4	●	
HIGEN Motor(former OTIS)	FDA	FDA6000/7000	●	
LS MECAPION(former Metronix)	Anypack	APD-VS/VP/VK/VN□□	●	
Parker Hannifin	Compax3	All models	●	
LinMot	LinRS	B1100/E1100/E1200/E1400	●	
<b>Screw Driver</b>				
KOLVER Srl	EDU	2AE/TOP/TA/MITO	●	
	MT Focus	400	●	
Atlas Copco	Power Focus	6000	●	●
TOHNICHI	CEM/CTB	CEM3-G/CTB2-G	●	
SEHAN Electools	SHC	All models	●	
<b>Measurement</b>				
YOKOGAWA Electric Corporation	Chart Recorder	μR10000/20000		●
SAMAHN TECH	Air Speed Meter	Air Speed Meter	●	
Ophir Optronics Solutions	Laser Power Meter	Nova II - Thermopile	●	
ROOTECH	Digital Power Meter	Accura Series	●	●
Green Power	CPS	CPS Master / Slave	●	
DONGDO TECH	ML	ML Series	●	
SERVOMEX	DF	DF-3□□E, DF-7□□	●	
Tiger Optics	HALO	HALO KA, HALO 3	●	
MKP	MFC	VIC-D2000 Series	●	
OMRON Industrial Automation	EQUO Series	Air Thermo Station		●
<b>Wireless Data Receiver</b>				
PATLITE	WDR	WDR-LE-Z2		●
<b>Multiplexer</b>				
S.I TECH	MUX	MUX	●	
<b>Camera</b>				
S & E	TMS	TMS 080/160		●
<b>Motor</b>				
CKD	ABSODEX	All models	●	
<b>Printer</b>				
ZEBRA	Printer	Printer	●	●
<b>DDC</b>				
ASIC	DDC	DDC	●	
Speed tech	ExtDDC	ST/PS, ST/RS, ASIC/2-7040	●	
<b>Fieldbus</b>				
EtherCAT				●
CANopen			●	
Ethernet/IP				●
<b>Industrial Control System</b>				
OPC UA				●
<b>Building Automation</b>				
BACnet/IP				●
BACnet/MSTP			●	
<b>Power System Automation</b>				
IEC 60870-5-101			●	
DNP3				●
<b>Image Stream</b>				
Cognex Corporation	Insight Vision	Insight Vision		●
Leuze Electronic	IPS 200i	IPS 200i		●
<b>Other Standard Protocol</b>				
SECS	HSMS			●
IP Camera	RTSP/RTP			●
NMEA0183			●	
IPC-Hermes Standard	IPC-Hermes	Upstream/DownStream		●

\* This connectable device list can be changed and updated per development situation





Detachable Aluminum Body with Multimedia Functions  
Premium/Standard/ATEX Model

EMBEDDED HMI

SMART X HMI



INTERFACE

SERIAL 3 PORTS | ETHERNET 2 CHANNEL | USB HOST 2 PORTS | USB OTG | SD CARD  
OPTION MODULE | CAMERA | HDMI OUT | AUDIO OUT | VIDEO IN

\* Multimedia functions are supported only in premium model

CERTIFICATION



FEATURES

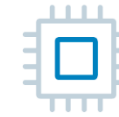

QUAD CORE CPU

Quad core processor supplying rapid processing speed



16M FULL COLOR

Bright and vivid full color, supports vector image library



ALUMINUM FRAME

Aluminum body with outstanding durability and splendid design



DETACHABLE UNIT STRUCTURE

Efficient combination of variable-size display unit and process unit depend on system requirement



SUPPORTING 2 ETHERNET CHANNELS

2 Ethernet channels with different IP



FRONT-SIDE OTG USB

Supporting both HOST mode(USB devices i.e.memory, barcode reader, camera, etc) and program transmission mode



T6 TEMPERATURE LEVEL CERTIFICATION

KCs(Korea), CCC(China), ATEX(Europe), Hazloc(North America), IECEx(Global) certification



MULTIMEDIA FEATURE(PREMIUM MODEL)

Front-side camera, audio output, video input, HDMI output

## DISPLAY UNIT

## PREMIUM MODEL

Functional	TOPRD1520X	TOPRD1220X	TOPRD1020S
Display	Display Type	15" TFT Color	12.1" TFT Color
	Color		16M Colors
	Display Area(mm)	304.1x228.1	246x184.5
	Resolution(dot)	1024x768	1024x768
	Brightness Level		10 Levels(by software)
	Backlight Type		LED
Touch	Backlight Life		50,000 hours
	Touch Type		Analog resistive film
	Resolution(Cell)	1024x768	800x600
Embedded Device	Touch Life		1 million times or more
	Front Camera		USB UVC Max. Resolution: 640x480
Structure	Panel Cut(mm)	355x286	306x247
	External Dimension(mm)	370x301x36.7	320x261x34.2
	Weight(kg)	3.58	2.44

\* Process unit can be assembled with variable display units

## PROCESS UNIT

Functional	TOPRP20D	
Interface	Serial COM1	RS-232C, RS-422/485 Asynchronous +5Vdc PWR Data bit: 7/8 bits, Stop bit: 1/2 bits, Parity bit: None/Odd/Even Baud rate: 2400~115.2kbps Connector: DSUB 9pin x 1
	Serial COM2	RS-232C, RS-422/485 Asynchronous Data bit: 7/8 bits, Stop bit: 1/2 bits, Parity bit: None/Odd/Even Baud rate: 2400~115.2kbps Connector: DSUB 9pin x 1
	Serial COM3	RS-485 Asynchronous Data bit: 7/8 bits, Stop bit: 1/2 bits, Parity bit: None/Odd/Even Baud rate: 2400~115.2kbps Connector: 3.5mm 3pin x 1
	Ethernet	IEEE802.3i/IEEE802.3u, 10BASE-T/100BASE-TX Connector: RJ-45 x 2
	USB Host	USB 2.0 Compatible, Output 5Vdc/0.5A Support: USB Storage, USB Barcode Scanner(Standard Keyboard Protocol) Connector: USB Type A x 2
	USB OTG	USB 2.0 Compatible, Output 5Vdc/0.5A, Max 3m Support: USB Storage, USB Barcode Scanner(Standard Keyboard Protocol) Connector: USB Micro-B(Front) x 1
	SD Card	SD Card Slot x 1, SDHC(MAX 32GB)
	Option Modules	CAM32
	HDMI Output	HDMI v1.4a, HDMI Output, Max. Resolution: 1920x1080 at 60Hz Connector: HDMI x 1
	Video Input	Decodes NTSC, PAL or SECAM composite video, S-Video Connector: RCA socket x 1
Memory & Others	Audio Output	Stereo output Connector: 3.5mm Audio socket x 1
	Printer	Roll Printer(EPSON protocol): RS-232C
	Screen memory	128MB
	Backup memory	512KB: System buffer(10K Word), Including Alarm/Logging/Recipe
	Backup Period	Permanent
	Real Time Clock	Built in
Structure	Status LED	3 LEDs(Power, Operation, Link) Built in
	External Dimension(mm)	201.6x147.6x37.3
	Weight(kg)	0.82

## DISPLAY UNIT

## STANDARD MODEL

Functional	TOPRD1510X	TOPRD1210S	TOPRD1010S
Display	Display Type	15" TFT Color	12.1" TFT Color
	Color		16M Colors
	Display Area(mm)	304.1x228.1	246x184.5
	Resolution(dot)	1024x768	800x600
	Brightness Level		10 Levels(by software)
	Backlight Type		LED
Touch	Backlight Life		50,000 hours
	Touch Type		Analog resistive film
	Resolution(Cell)	1024x768	800x600
Embedded Device	Touch Life		1 million times or more
	Panel Cut(mm)	355x286	306x247
Structure	External Dimension(mm)	370x301x36.7	320x261x34.2
	Weight(kg)	3.58	2.44
			1.88

\* Process unit can be assembled with variable display units

## PROCESS UNIT

Functional	TOPRP10D	
Interface	Serial COM1	RS-232C, RS-422/485 Asynchronous +5Vdc PWR Data bit: 7/8 bits, Stop bit: 1/2 bits, Parity bit: None/Odd/Even Baud rate: 2400~115.2kbps Connector: DSUB 9pin x 1
	Serial COM2	RS-232C, RS-422/485 Asynchronous Data bit: 7/8 bits, Stop bit: 1/2 bits, Parity bit: None/Odd/Even Baud rate: 2400~115.2kbps Connector: DSUB 9pin x 1
	Serial COM3	RS-485 Asynchronous Data bit: 7/8 bits, Stop bit: 1/2 bits, Parity bit: None/Odd/Even Baud rate: 2400~115.2kbps Connector: 3.5mm 3pin x 1
	Ethernet	IEEE802.3i/IEEE802.3u, 10BASE-T/100BASE-TX Connector: RJ-45 x 2
	USB Host	USB 2.0 Compatible, Output 5Vdc/0.5A Support: USB Storage, USB Barcode Scanner(Standard Keyboard Protocol) Connector: USB Type A x 2
	USB OTG	USB 2.0 Compatible, Output 5Vdc/0.5A, Max 3m Support: USB Storage, USB Barcode Scanner(Standard Keyboard Protocol) Connector: USB Micro-B(Front) x 1
	SD Card	SD Card Slot x 1, SDHC(MAX 32GB)
	Option Modules	EtherCAT, CAM32
	Printer	Roll Printer(EPSON protocol): RS-232C
	Memory & Others	Screen memory Backup memory Backup Period Real Time Clock Status LED
Structure	Screen memory	128MB
	Backup memory	512KB: System buffer(10K Word), Including Alarm/Logging/Recipe
	Backup Period	Permanent
	Real Time Clock	Built in
	Status LED	3 LEDs(Power, Operation, Link) Built in
	External Dimension(mm)	201.6x147.6x37.3
	Weight(kg)	0.82

## DISPLAY + PROCESS UNIT

## PREMIUM/STANDARD MODEL

Functional	15"	12.1"	10.4"
Power	Input Voltage		24Vdc(20~28Vdc)
	Power Consumption	18W	15W
	Voltage Sag		24Vdc, Within 10ms
	Insulation Resistance		500Vdc, 10MΩ
	Operation Temperature(°C)		-10 ~ +50
	Storage Temperature(°C)		-20 ~ +60
Environment	Operation Humidity(%RH)		0 ~ 90(No Dew)
	Atmosphere		No corrosive gas
	Vibration Endurance		Amplitude: 10±F < 25Hz(2G) X,Y,Z each direction(for 30 minutes)
	Noise Immunity		1000Vp-p(Pulse width 1µs)
	Static Electricity Discharge		Connective discharge from EN61000-4-2: ±4kV
	Shock Endurance		10G X,Y,Z each direction(for 3 times)
	Ground Connection		Class 3(100Ω or less)
	Protection Classification		IP65(Front)
	Certification		CE, KC, UL
	Weight(kg)	4.4	3.26
Structure	Cooling System		Natural air circulation
	Case Material		AL(Aluminum)

## DISPLAY UNIT

## ATEX MODEL

Functional		TOPRT1210SD-Ex
Display	Display Type	12.1" TFT Color
	Color	16M Colors
	Display Area(mm)	246x184.5
	Resolution(dot)	1024x768
	Brightness Level	10 Levels(by software)
Touch	Backlight Type	LED
	Backlight Life	50,000 hours
	Touch Type	Analog resistive film
	Resolution(Cell)	1024x768
Touch Life	Touch Life	1 million times or more
	Embedded Device	Front Camera USB UVC Max. resolution: 640x480, 4 Adjustable angles: Up 20°, 10°, 0°, Down 10°
Structure	Panel Cut(mm)	306x247
	External Dimension(mm)	320x261x34.2
	Weight(kg)	2.44

## PROCESS UNIT

Functional		TOPRT1210SD-Ex
Interface	Serial COM1	RS-232C, RS-422/485 Asynchronous +5Vdc PWR Data bit: 7/8 bits, Stop bit: 1/2 bits, Parity bit: None/Odd/Even Baud rate: 2400~115.2kbps Connector: DSUB 9pin x 1
	Serial COM2	RS-232C, RS-422/485 Asynchronous Data bit: 7/8 bits, Stop bit: 1/2 bits, Parity bit: None/Odd/Even Baud rate: 2400~115.2kbps Connector: DSUB 9pin x 1
	Serial COM3	RS-485 Asynchronous Data bit: 7/8 bits, Stop bit: 1/2 bits, Parity bit: None/Odd/Even Baud rate: 2400~115.2kbps Connection: 3.5mm 3pin x 1
	Ethernet	IEEE802.3i/IEEE802.3u, 10BASE-T/100BASE-TX Connector: RJ-45 x 2
	USB Host	USB 2.0 Compatible, Output 5Vdc/0.5A Support: USB Storage, USB Barcode Scanner(Standard Keyboard Protocol) Connector: USB Type A x 2
	USB OTG	USB 2.0 Compatible, Output 5Vdc/0.5A, Max 3m Support: USB Storage, USB Barcode Scanner(Standard Keyboard Protocol) Connector: USB Micro-B(Front) x 1
	SD Card	SD Card Slot x 1, SDHC(Max. 32GB)
	Option Modules	EtherCAT, CAM32
	Printer	Roll Printer(EPSON protocol): RS-232C
	Memory & Others	Screen Memory
Backup Memory		512KB: System Buffer(10K Word), including Alarm/Logging/Recipe
Backup Period		Permanent
Real Time Clock		Built in
Status LED		3 LEDs(Power, Operation, Link) Built in
Structure	External Dimension(mm)	201.6x147.6x37.3
	Weight(kg)	0.82

## DISPLAY + PROCESS UNIT

Functional		TOPRT1210SD-Ex
Power	Input Voltage	24Vdc(20~28Vdc)
	Power Consumption	15W or less
	Voltage Sag	24Vdc, Within 10ms
	Insulation Resistance	500Vdc, 10MΩ
	Operation Temperature(°C)	-10 ~ +50
Environment	Storage Temperature(°C)	-20 ~ +60
	Operation Humidity(%RH)	0 ~ 90(No Dew)
	Atmosphere	No corrosive gas
	Vibration Endurance	Amplitude: 10±F < 25Hz(2G) X,Y,Z each direction(for 30 minutes)
	Noise Immunity	1000Vp-p(Pulse width 1µs)
	Static Electricity Discharge	Connective discharge from EN61000-4-2: ±4kV
	Shock Endurance	10G X,Y,Z each direction(for 3 times)
	Ground Connection	Class 3(100Ω or less)
	Protection Classification	IP65(Front) for CE/KC/UL, IP54(Front) for CCC, IP4X(Front) for KCs
	Certification	CE, KC, UL, KCs, CCC, ATEX, IECEx, Hazloc
Structure	Weight(kg)	3.26
	Cooling System	Natural air circulation
	Case Material	AL(Aluminum)

## DRAWING

\* Each inch model's blueprint size of premium model and standard model are same  
\* Each port's name and position are referred to 15 inch model's blueprint

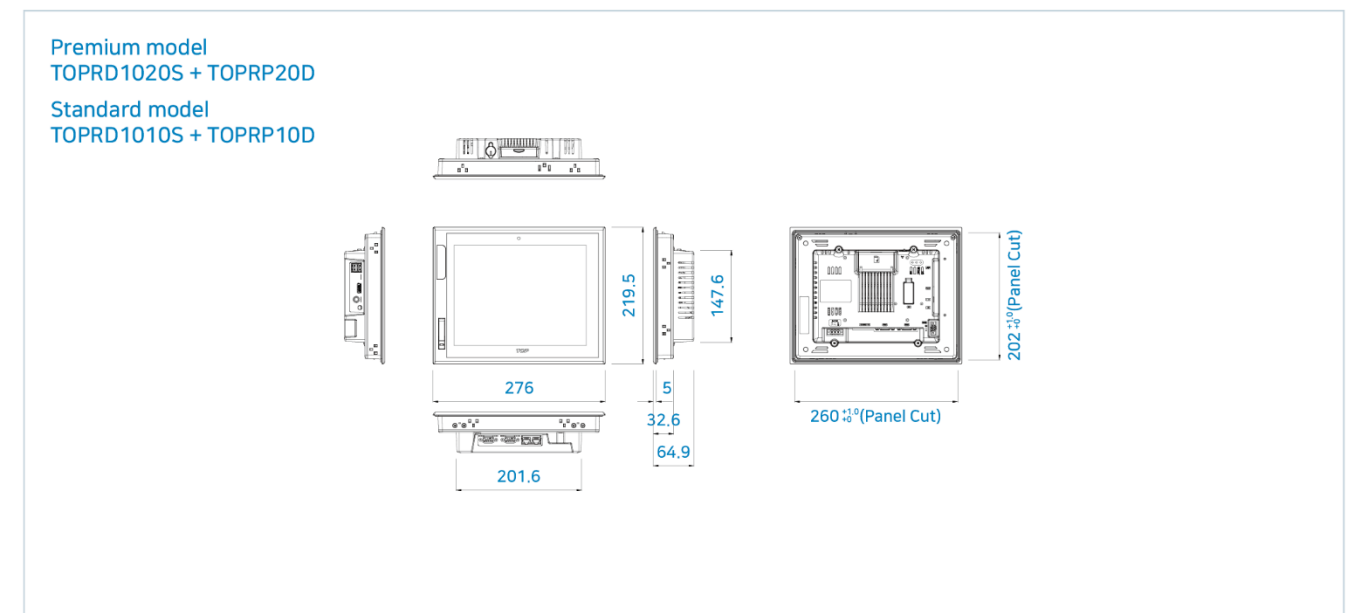
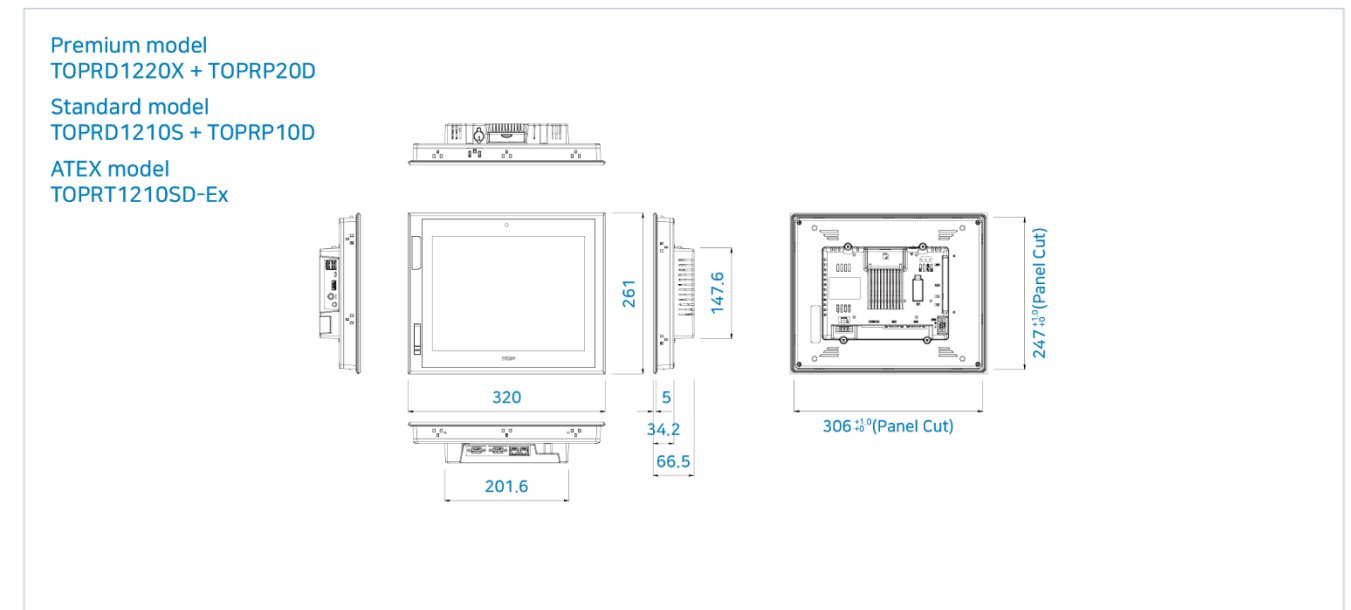
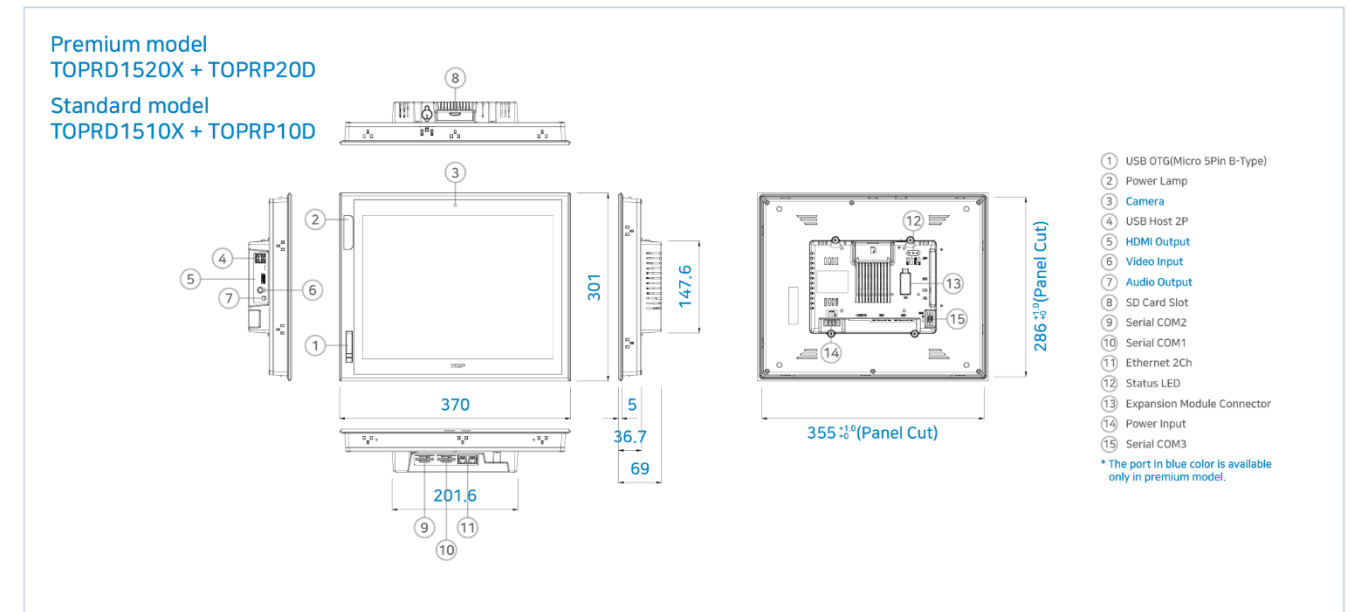





The Series Developed TOPR's Function from XTOP Products

Normal/EX Model

EMBEDDED HMI

SMART X HMI



INTERFACE

SERIAL 3(2) PORTS | ETHERNET 2(1) CHANNEL | USB HOST | USB OTG | SD CARD

\* 15", 12", 10", 8", 5" please check the number of ports by each model

CERTIFICATION



FEATURES

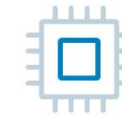

QUAD CORE CPU

Quad core processor supplying rapid processing speed



16M FULL COLOR

Bright and vivid full color, supports vector image library



TOUCH DRAG FEATURE

Available touch drag to make a picture memo or scroll down to appear top-side menu



RRFIND INTEGRATED BODY

Refined integrated body with advantage of easy



COMPATIBILITY WITH XTOP SERIES

Same panel cut size of XTOP series easy to replace discontinued XTOP model

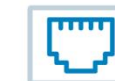

SUPPORTING 2 ETHERNET CHANNELS

2 Ethernet channels with different IP (10" or upper model)



FRONT-SIDE OTG USB

Supporting both HOST mode(USB devices i.e.Memory, barcode reader, camera, etc) and program transmission mode



T6 TEMPERATURE LEVEL CERTIFICATION

KCs(Korea), CCC(China), ATEX(Europe), Hazloc(North America), IECEx(Global) certification

# TOPRX SPECIFICATIONS

Functional	General model	TOPRX 1500XD	TOPRX 1200XD	TOPRX 1200SD	TOPRX 1000SD	TOPRX 1000VD	TOPRX 0800SD	TOPRX 0800VD	TOPRX 0500VD	
	Explosion proof model	TOPRX 1500XD-Ex	TOPRX 1200XD-Ex	TOPRX 1200SD-Ex	TOPRX 1000SD-Ex	TOPRX 1000VD-Ex				
Display	Display Type	15" TFT Color	12.1" TFT Color	12.1" TFT Color	10.4" TFT Color	10.4" TFT Color	8.4" TFT Color	8.4" TFT Color	5.6" TFT Color	
	Color	16M Colors								
	Display Area(mm)	304.1x228.1	246x184.5	246x184.5	211.2x158.4	211.2x158.4	170.4x127.8	170.9x128.2	112.9x84.7	
	Resolution(dot)	1024x768	1024x768	800x600	800x600	640x480	800x600	640x480	640x480	
	Brightness Level	10 Levels(by software)								
	Backlight Type	LED								
Touch	Backlight Life	50,000 hours								
	Touch Type	Analog resistive film								
	Resolution(cell)	1024x768	1024x768	800x600	800x600	640x480	800x600	640x480	640x480	
Touch Life	1 million times or more									
Interface	Serial COM1	RS-232C, RS-422/485 Asynchronous +5Vdc PWR Data bit: 7/8 bits, Stop bit: 1/2 bits, Parity bit: None/Odd/Even Baud rate: 2400~115.2kbps Connector: DSUB 9pin x 1								
	Serial COM2	RS-232C, RS-422/485 Asynchronous Data bit: 7/8 bits, Stop bit: 1/2 bits, Parity bit: None/Odd/Even Baud rate: 2400~115.2kbps Connector: DSUB 9pin x 1								
	Serial COM3	RS-485 Asynchronous Data bit: 7/8 bits, Stop bit: 1/2 bits, Parity bit: None/Odd/Even Baud rate: 2400~115.2kbps Connector: 3.5mm 3pin x 1								Not available
	Ethernet	IEEE802.3i/IEEE802.3u, 10BASE-T/100BASE-TX Connector: RJ-45 x 2			IEEE802.3i/IEEE802.3u, 10BASE-T/100BASE-TX Connector: RJ-45 x 1					
Memory & Others	USB Host	USB 2.0 Compatible, Output 5Vdc/0.5A Support: USB Storage, USB Barcode Scanner(Standard Keyboard Protocol) Connector: USB Type A x 1								
	USB OTG	USB 2.0 Compatible, Output 5Vdc/0.5A, Max 3m Support: USB Storage, USB Barcode Scanner(Standard Keyboard Protocol) Connector: USB Mini-B(Front) x 1								
	SD Card	SD Card Slot x 1, SDHC(MAX 32GB)								
	Printer	Roll Printer(EPSON protocol): RS-232C								
	Screen Memory	128MB								
Power	Backup Memory	512KB: System buffer(10K Word), Including Alarm/Logging/Recipe								
	Backup Period	Permanent								
	Real Time Clock	Built in								
	Status LED	3 LEDs(Power, Operation, Link) Built in								
Environment	Input Voltage	24Vdc(20~28Vdc)								
	Power Consumption	18W or less	15W or less					12W or less		
	Voltage Sag	24Vdc, Within 10ms								
	Insulation Resistance	500Vdc, 10MΩ								
Structure	Operation Temperature(°C)	-10 ~ +50								
	Storage Temperature(°C)	-20 ~ +60								
	Operation Humidity(%RH)	0 ~ 90(No dew)								
	Atmosphere	No corrosive gas								
	Vibration Endurance	Amplitude: 10≤F<25Hz(2G) X,Y,Z each direction(for 30 minutes)								
	Noise Immunity	1000Vp-p(Pulse width 1μs)								
	Static Electricity Discharge	Connective discharge from EN61000-4-2: ±4kV								
	Shock Endurance	10G X,Y,Z each direction(for 3 times)								
	Ground Connection	Class 3(100Ω under)								
	Protection Classification	General model: IP65(Front), Explosion proof model: IP54(Front) for CCC, IP4X(Front) for KCs								
Structure	Certification	General model: CE, KC, UL Explosion proof model: CE, KC, UL, KCs, CCC, ATEX, IECEx, Hazloc								
	Panel Cut(mm)	355x286	306x247	306x247	260x202	260x202	222x168	222x168	158x126	
	External Dimension(mm)	369x300x67.2	320x261x64.7	320x261x64.7	274x216x64.7	274x216x64.7	236x182x58.9	236x182x58.9	172x140x58	
	Weight(kg)	2.78	2.18	2.18	1.68	1.68	1.06	1.06	0.62	
	Cooling System	Natural air circulation								
Case Material	PC(Resistance to flame)									

# DRAWING

Standard model  
TOPRX1500XD  
EX model  
TOPRX1500XD-Ex

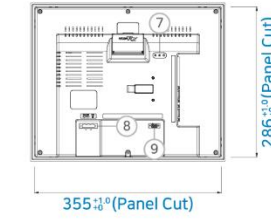
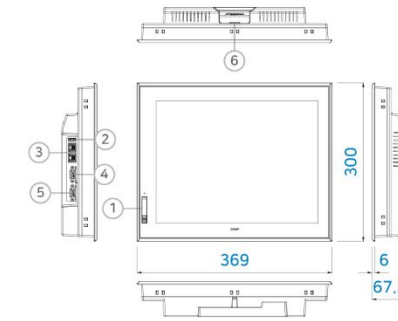

- ① USB OTG(Mini 5Pin B-Type)
- ② USB Host 1P
- ③ Ethernet 2Ch
- ④ Serial COM2
- ⑤ Serial COM1
- ⑥ SD Card Slot
- ⑦ Status LED
- ⑧ Power Input
- ⑨ Serial COM3

Standard model  
TOPRX1200XD  
TOPRX1200SD  
EX model  
TOPRX1200XD-Ex  
TOPRX1200SD-Ex

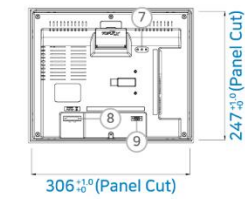
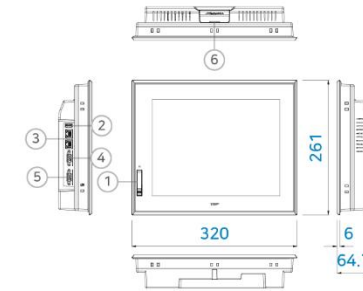

- ① USB OTG(Mini 5Pin B-Type)
- ② USB Host 1P
- ③ Ethernet 2Ch
- ④ Serial COM2
- ⑤ Serial COM1
- ⑥ SD Card Slot
- ⑦ Status LED
- ⑧ Power Input
- ⑨ Serial COM3

Standard model  
TOPRX1000SD  
TOPRX1000VD  
EX model  
TOPRX1000SD-Ex  
TOPRX1000VD-Ex

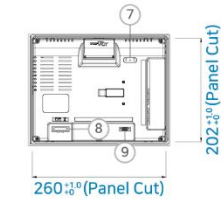
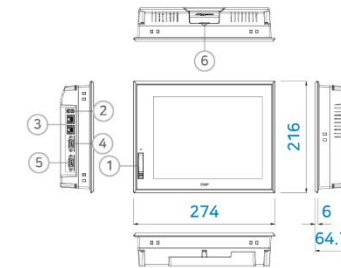

- ① USB OTG(Mini 5Pin B-Type)
- ② USB Host 1P
- ③ Ethernet 2Ch
- ④ Serial COM2
- ⑤ Serial COM1
- ⑥ SD Card Slot
- ⑦ Status LED
- ⑧ Power Input
- ⑨ Serial COM3

Standard model  
TOPRX0800SD  
TOPRX0800VD

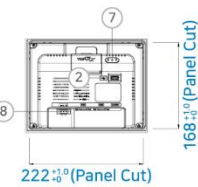
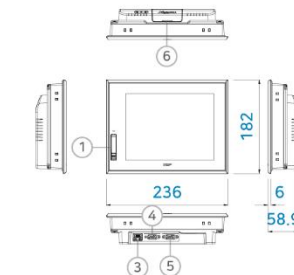

- ① USB OTG(Mini 5Pin B-Type)
- ② USB Host 1P
- ③ Ethernet 1Ch
- ④ Serial COM2
- ⑤ Serial COM1
- ⑥ SD Card Slot
- ⑦ Status LED
- ⑧ Power Input

Standard model  
TOPRX0500VD

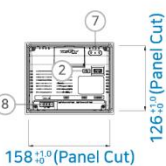
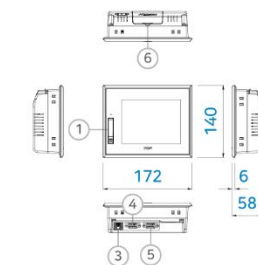

- ① USB OTG(Mini 5Pin B-Type)
- ② USB Host 1P
- ③ Ethernet 1Ch
- ④ Serial COM2
- ⑤ Serial COM1
- ⑥ SD Card Slot
- ⑦ Status LED
- ⑧ Power Input





With a Wider Screen  
**TOPRW Series**

EMBEDDED HMI

SMART X HMI



**INTERFACE**

SERIAL 2 PORTS | ETHERNET 1 CHANNEL | **USB HOST** | USB OTG | SD CARD

\* USB HOST functions is supported only in 10" and 7"

**CERTIFICATION**



**FEATURES**

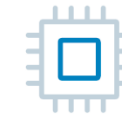

**QUAD CORE CPU**

Quad core processor supplying rapid processing speed



**16M FULL COLOR**

Bright and vivid full color, supports vector image library



**TOUCH DRAG FEATURE**

Available touch drag to make a picture memo or scroll down to appear top-side menu



**REFINED INTEGRATED BODY**

Refined integrated body with advantage of easy



**800x480 HIGH RESOLUTION**

With 10", 7", 5" wide screen ratio, expansion of work-area available



**COMPATIBILITY WITH XTOP SERIES**

With same panel cut size of XTOP, easy to replace discontinued XTOP model



**FRONT-SIDE OTG USB**

Supporting both HOST mode(USB devices i.e.Memory, barcode reader, camera, etc) and program transmission mode



# TOPRW SPECIFICATIONS

Functional	TOPRW1000WD	TOPRW0700WD	TOPRW0700WD NE	TOPRW0500WD
Display	Display Type	10.2" TFT Color	7" TFT Color	5" TFT Color
	Color		16M Colors	
	Display Area(mm)	222x132.48	154x86	108x64.8
	Resolution(dot)		800x480	
	Brightness Level		10 Levels(by software)	
Touch	Backlight Type		LED	
	Backlight Life		50,000 hours	
	Touch Type		Analog resistive film	
	Resolution(Cell)		800x480	
	Touch Life		1 million times or more	
Serial COM1		RS-232C Asynchronous +5Vdc PWR Data bit: 7/8 bits, Stop bit: 1/2 bits, Parity bit: None/Odd/Even Baud rate: 2400~115.2kbps Connector: DSUB 9pin x 1		
	Serial COM2	RS-232C, RS-422/485 Asynchronous Data bit: 7/8 bits, Stop bit: 1/2 bits, Parity bit: None/Odd/Even Baud rate: 2400~115.2kbps Connector: DSUB 9pin x 1		
Interface	Ethernet	IEEE802.3i/IEEE802.3u, 10BASE-T/100BASE-TX Connector: RJ-45 x 1	Not available	IEEE802.3i/IEEE802.3u, 10BASE-T/100BASE-TX Connector: RJ-45 x 1
	USB Host	USB 2.0 Compatible, Output 5Vdc/0.5A Support: USB Storage, USB Barcode Scanner(Standard Keyboard Protocol) Connector: USB Type A x 1		Not available
USB OTG		USB 2.0 Compatible, Output 5Vdc/0.5A, Max 3m Support: USB Storage, USB Barcode Scanner(Standard Keyboard Protocol) Connector: USB Mini-B(Front) x 1		Connector: USB Mini-B(Rear) x 1
Memory & Others	SD Card		SD Card Slot x 1, SDHC(MAX 32GB)	
	Printer		Roll Printer(EPSON protocol): RS-232C	
	Screen Memory		128MB	
	Backup Memory		512KB: System buffer(10K Word), Including Alarm/Logging/Recipe	
	Backup Period		Permanent	
Power	Real Time Clock		Built in	
	Status LED		3 LEDs(Power, Operation, Link) Built in	
	Input Voltage		24Vdc(20~28Vdc)	
	Power Consumption	15W or less		12W or less
	Voltage Sag		24Vdc, Within 10ms	
Environment	Insulation Resistance		500Vdc, 10MΩ	
	Operation Temperature(°C)		-10 ~ +50	
	Storage Temperature(°C)		-20 ~ +60	
	Operation Humidity(%RH)		0 ~ 90(No dew)	
	Atmosphere		No corrosive gas	
	Vibration Endurance		Amplitude: 10sF<25Hz(2G) X,Y,Z each direction(for 30 minutes)	
	Noise Immunity		1000Vp-p(Pulse width 1μs)	
	Static Electricity Discharge		Connective discharge from EN61000-4-2: ±4kV	
	Shock Endurance		10G X,Y,Z each direction(for 3 times)	
	Ground Connection		Class 3(100Ω under)	
Structure	Protection Classification		IP65(Front)	
	Certification		CE, KC, UL	CE, KC, UL
	Panel Cut(mm)	260x202	197x127	136x100
	External Dimension(mm)	274x216x64.7	212x145x45.6	150x114x41.8
	Weight(kg)	1.7	0.72	0.4
Cooling System		Natural air circulation		
Case Material		PC(Resistance to flame)		

# DRAWING

\* TOPRW0700WD NE model does not support Ethernet

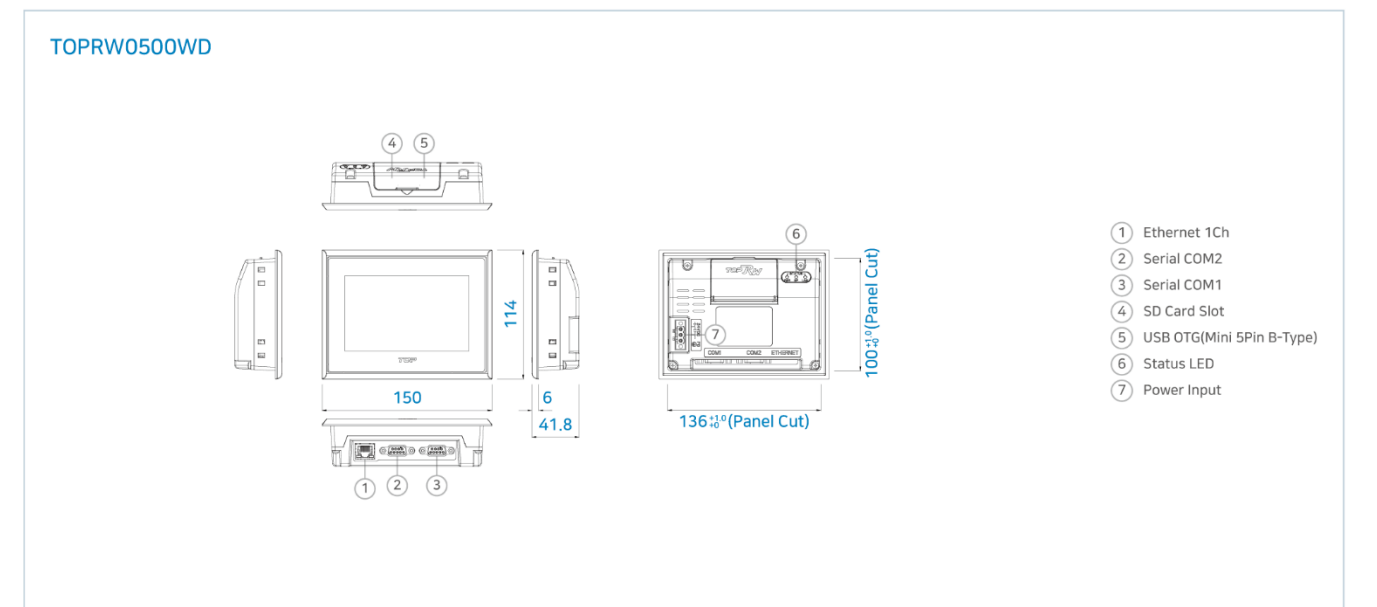
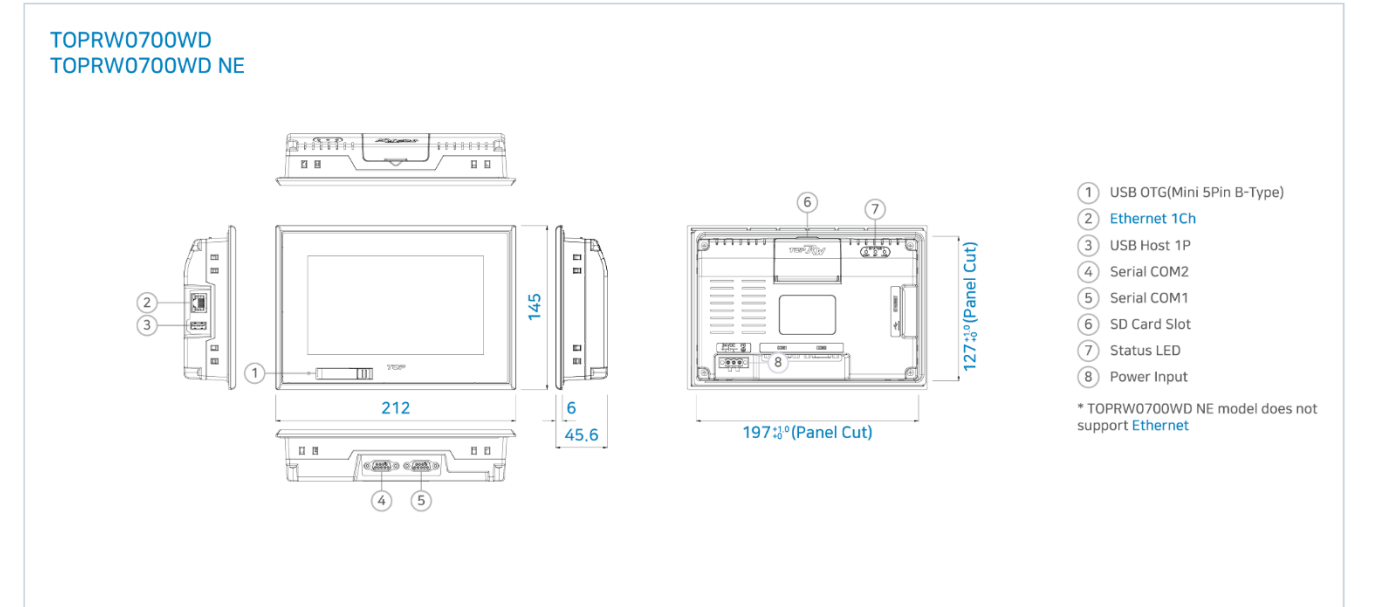
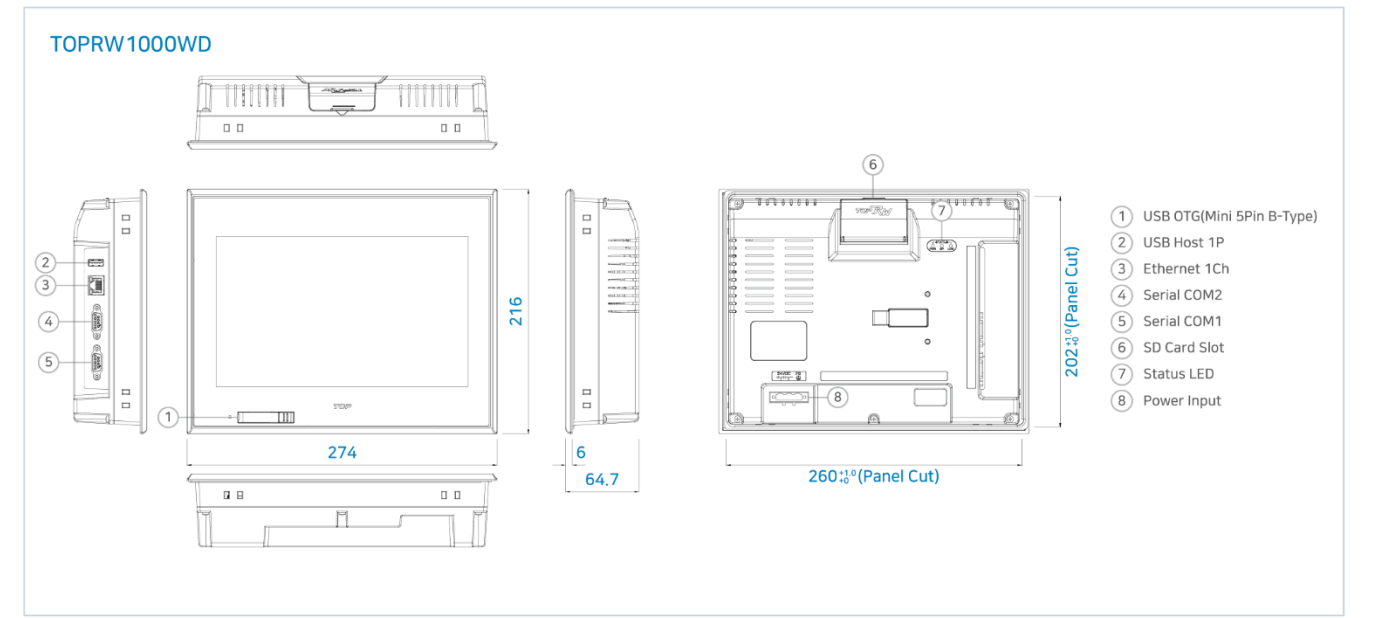



Integrated I/O HMI  
with Flexible Composition and Control  
**TOPRW-IO Series**

EMBEDDED HMI

SMART X HMI



**INTERFACE**

SERIAL 2 PORTS | ETHERNET 1 CHANNEL | USB HOST | USB OTG | SD CARD

**CERTIFICATION**



**FEATURES**



**FLEXIBLE I/O SUPPORT**

DIGITAL INPUT 16ch,  
DIGITAL OUT SINK 16ch,  
\* ANALOG INPUT(Voltage 2ch, current 2ch),  
\* ANALOG OUTPUT(Voltage 2ch, current 2ch),  
\* RTD 2ch  
\* Analog and RTD are supported only  
in TOPRW0700WD-IO

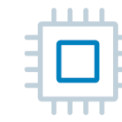

**QUAD CORE CPU**

Quad core processor supplying rapid  
processing speed



**16M FULL COLOR**

Bright and vivid full color,  
supports vector image library



**TOUCH DRAG FEATURE**

Available touch drag to make a picture  
memo or scroll down to appear top-side  
menu



**REFINED INTEGRATED BODY**

Refined integrated body with advantage  
of easy



**800x480 HIGH RESOLUTION**

With 7" wide screen ratio,  
expansion of work-area available



**COMPATIBILITY WITH XTOP SERIES**

With same panel cut size of XTOP,  
easy to replace discontinued XTOP model



**FRONT-SIDE OTG USB**

Supporting both HOST mode(USB devices  
i.e.Memory, barcode reader, camera, etc)  
and program transmission mode

# TOPRW-IO SPECIFICATIONS

Functional	TOPRW0700WD-IO	TOPRW0710WD-IO		
Display	Display Type	7" TFT Color		
	Color	16M Colors		
	Display Area(mm)	154x86		
	Resolution(dot)	800x480		
	Brightness Level	10 Levels(by software)		
	Backlight Type	LED		
Touch	Backlight Life	50,000 hours		
	Touch Type	Analog resistive film		
	Resolution(Cell)	800x480		
Interface	Touch Life	1 million times or more		
	Serial COM1	RS-232C Asynchronous +5Vdc PWR Data bit: 7/8 bits, Stop bit: 1/2 bits, Parity bit: None/Odd/Even Baud rate: 2400~115.2kbps Connector: DSUB 9pin x 1		
	Serial COM2	RS-232C, RS-422/485 Asynchronous Data bit: 7/8 bits, Stop bit: 1/2 bits, Parity bit: None/Odd/Even Baud rate: 2400~115.2kbps Connector: DSUB 9pin x 1		
	Ethernet	IEEE802.3i/IEEE802.3u, 10BASE-T/100BASE-TX AUTO MDIX Connector: RJ-45 x 1		
	USB Host	USB 2.0 Compatible, Output 5Vdc/0.5A Support: USB Storage, USB Barcode Scanner(Standard Keyboard Protocol) Connector: USB Type A x 1		
	USB OTG	USB 2.0 Compatible, Output 5Vdc/0.5A, Max 3m Support: USB Storage, USB Barcode Scanner(Standard Keyboard Protocol) Connector: USB Mini-B(Front) x 1		
	SD Card	SD Card Slot x 1, SDHC(MAX 32GB)		
	Printer	Roll Printer(EPSON protocol): RS-232C		
	IO	IO Function	Digital Input 16ch, Digital Output 16ch, Analog Input(Voltage 2ch, Current 2ch), Analog Output(Voltage 2ch, Current 2ch), RTC 2ch	Digital Input 16ch, Digital Output 16ch
		Screen Memory	128MB	
Memory & Others	Backup Memory	512KB: System buffer(10K Word), Including Alarm/Logging/Recipe		
	Backup Period	Permanent		
	Real Time Clock	Built in		
Power	Status LED	3 LEDs(Power, Operation, Link) Built in		
	Input Voltage	24Vdc(20~28Vdc)		
	Power Consumption	15W or less		
	Voltage Sag	24Vdc, Within 10ms		
	Insulation Resistance	500Vdc, 10MΩ		
	Operation Temperature(°C)	-10 ~ +50		
Environment	Storage Temperature(°C)	-20 ~ +60		
	Operation Humidity(%RH)	0 ~ 90(No dew)		
	Atmosphere	No corrosive gas		
	Vibration Endurance	Amplitude: 10≤F<25Hz(2G) X,Y,Z each direction(for 30 minutes)		
	Noise Immunity	1000Vp-p(Pulse width 1μs)		
	Static Electricity Discharge	Connective discharge from EN61000-4-2: ±4kV		
	Shock Endurance	10G X,Y,Z each direction(for 3 times)		
	Ground Connection	Class 3(100Ω under)		
	Protection Classification	IP65(Front)		
	Certification	CE, KC		
Structure	Panel Cut(mm)	197x127		
	External Dimension(mm)	212x145x62.5		
	Weight(kg)	0.81		
	Cooling System	Natural air circulation		
	Case Material	Plastic		

# TOPRW-IO SPECIFICATIONS

Functional	Digital Input	Digital Output
Type	Input/Output Type	16 channels Sink and Source Type
Power	Input/Output Voltage	24Vdc typ. On-State Min. 11.0Vdc ~ Max. 28.8Vdc, Off-State Max. 5Vdc
	System Power Dissipation	Max. 70mA
	Input Current in On State	Max. 6mA/Channel@28.8Vdc
	Output Current in On State	N/A
	Max. On-State Voltage Drop	N/A
	Off-State Leakage Current	N/A
Interface	Typ. Input Impedance	Typ. 4.7KΩ
	Input/Output Signal Delay	Off to On: Max. 0.1ms On to Off: Max. 0.5ms
	Input Filter(Digital)	0.5ms
Other	Isolation	I/O to Logic: Photocoupler isolation
	Field Power	Typ. 24Vdc(11.0Vdc ~ 28.8Vdc)
Other	Wiring	AWG 26 to 20
	Pin No.	Removable Terminal Block 20P

\* Analog and RTD are supported only in TOPRW0700WD-IO

Functional	Temperature Input(RTD)	Analog Input (AIV)	Analog Input (AIC)	Analog Output (AOV)	Analog Output (AOC)
Type	Input / Output Type	2 Channels Analog RTD Type	2 Channels Analog Voltage Type	2 Channels Analog Current Type	2 Channels Analog Voltage Type
Power	Sensor Type and Input / Output Range	PT100 * -200.0 to +850.0°C	0 ~ 5 Vdc	0 ~ 20mA	0 ~ 5 Vdc
	System Power Dissipation	Max. 70mA@5.0Vdc			Max. 200mA
	Field power	N/A			Max. 60mA@24Vdc
Characteristic	Typ. Input Impedance	N/A	Min. 500KΩ	Max. 250Ω	N/A
	Load		N/A		Min. 5KΩ
	Data Format			16bits Integer	
Other	Resolution	0.0312°C/1bit	16bits, 0.076mV/1bit	16bits, 0.3uA/Bit	16bits, 0.076mV/1bit
	Conversion Time	Approx. 70ms, All Channel@50Hz			4ms/All Channel
	Module Error				±0.1% Full Scale@+25°C, ±0.3% Full Scale@0°C, +60°C
	Isolation				Capacitive isolation
Other	Common Type	2COM (1 Common/1 Channel)			2 COM(Single Common)
	Wiring				AWG 26 to 20
Other	Pin No.				Removable Terminal Block 10P(3.5mm pitch)

## DRAWING

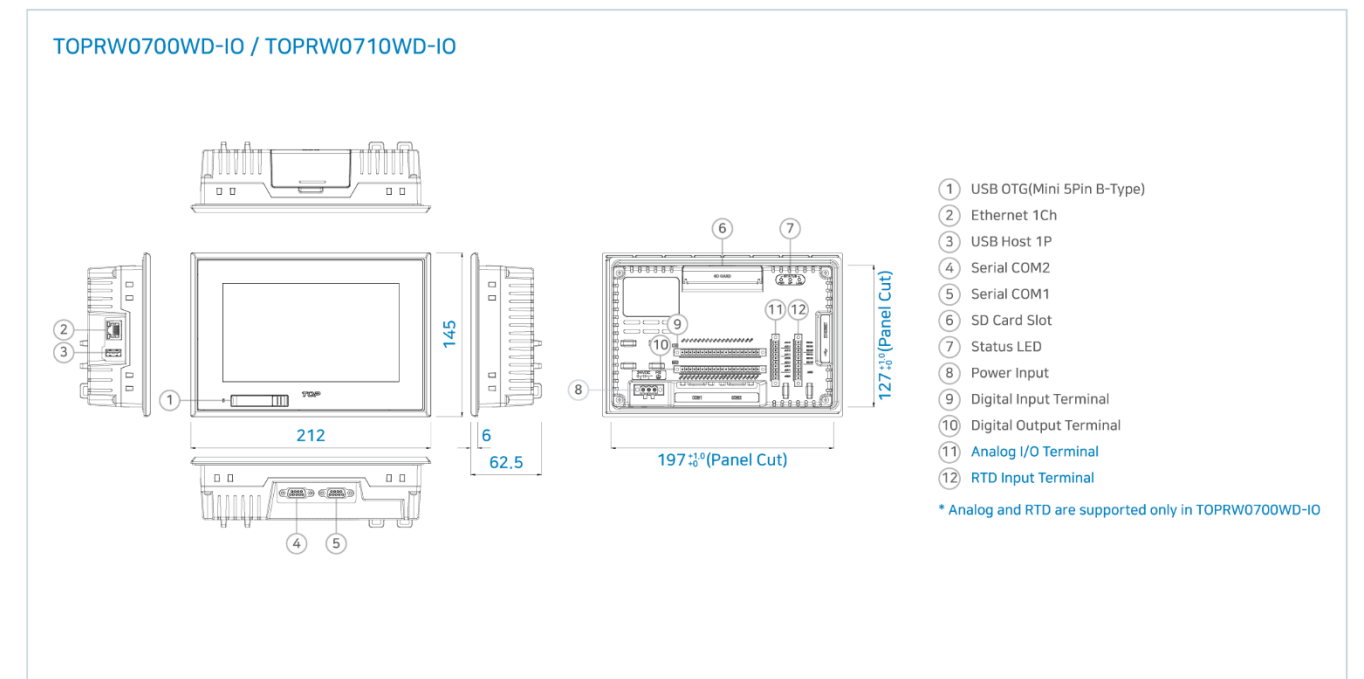

### Software Ladder Program

01 Ladder Programing based on IEC-61131-3

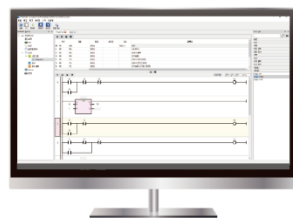

Ethernet



Connection

Ladder Program Operation

02 Ladder Operation by Sending a Program to TOPRW-IO Series

03 Ladder Monitoring on HMI Screen

- FAN
- SENSOR
- MOTOR
- LAMP
- ROBOT
- SERVO





Compact Size, Light and Convenient  
TOPRE Series

EMBEDDED HMI

SMART X HMI



INTERFACE

SERIAL 1 PORT | ETHERNET 1 CHANNEL | USB OTG | SD CARD

CERTIFICATION



FEATURES

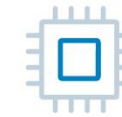

QUAD CORE CPU

Quad core processor supplying rapid processing speed



16M FULL COLOR

Bright and vivid full color, supports vector image library



TOUCH DRAG FEATURE

Available touch drag to make a picture memo or scroll down to appear top-side menu



REFINED INTEGRATED BODY

Refined integrated body with advantage of easy



4.3" COMPACT SIZE

Powerful performance with compact size



FRONT-SIDE OTG USB

Supporting both HOST mode(USB devices i.e.Memory, barcode reader, camera, etc) and program transmission mode

# TOPRE SPECIFICATIONS

Functional		TOPRE0400WD
Display	Display Type	4.3" TFT Color
	Color	16M Colors
	Display Area(mm)	95.04x53.85
	Resolution(dot)	480x272
	Brightness Level	10 Levels(by software)
	Backlight Type	LED
Touch	Backlight Life	50,000 hours
	Touch Type	Analog resistance film
	Resolution(Cell)	480x272
	Touch Life	1 million times or more
Interface	Serial COM1 (RS-232C Only)	RS-232C, RS-422/485 Asynchronous Data bit: 7/8 bits, Stop bit: 1/2 bits, Parity bit: None/Odd/Even Baud rate: 2400~115.2kbps
	Serial COM2 (RS-422/485 Only)	Connector: DSUB 9pin x 1
	Ethernet	IEEE802.3i/IEEE802.3u, 10BASE-T/100BASE-TX Connector: RJ-45 x 1 NE(No Ethernet) model: cannot support Ethernet interface
	USB OTG	USB 2.0 Compatible, Output 5Vdc/0.5A, Max 3m Support: USB Storage, USB Barcode Scanner(Standard Keyboard Protocol) Connector: USB Mini-B(Side) x 1
	SD Card	SD Card Slot x 1, SDHC(MAX 32GB)
	Printer	Roll Printer(EPSON protocol): RS-232C
Memory & Others	Screen Memory	64MB
	Backup Memory	512KB: System buffer(10K Word), Including Alarm/Logging/Recipe
	Backup Period	Permanent
	Real Time Clock	Built in
Power	Status LED	3 LEDs(Power, Operation, Link) Built in
	Input Voltage	24Vdc(20~28Vdc)
	Power Consumption	12W or less
	Voltage Sag	24Vdc, Within 10ms
	Insulation Resistance	500Vdc, 10MΩ
	Operation Temperature(°C)	-10 ~ +50
Environment	Storage Temperature(°C)	-20 ~ +60
	Operation Humidity(%RH)	0 ~ 90(No dew)
	Atmosphere	No corrosive gas
	Vibration Endurance	Amplitude: 10≤F < 25Hz(2G) X,Y,Z each direction(for 30 minutes)
	Noise Immunity	1000Vp-p(Pulse width 1μs)
	Static Electricity Discharge	Connective discharge from EN61000-4-2: ±4kV
	Shock Endurance	10G X,Y,Z each direction(for 3 times)
	Ground Connection	Class 3(100Ω under)
	Protection Classification	IP65(Front)
	Certification	CE, KC, UL
Structure	Panel Cut(mm)	121 x 95
	External Dimension(mm)	128.6 x 102.6 x 38
	Weight(kg)	0.28
	Cooling System	Natural air circulation
Case Material	PC(Resistance to flame)	

# DRAWING

TOPRE0400WD

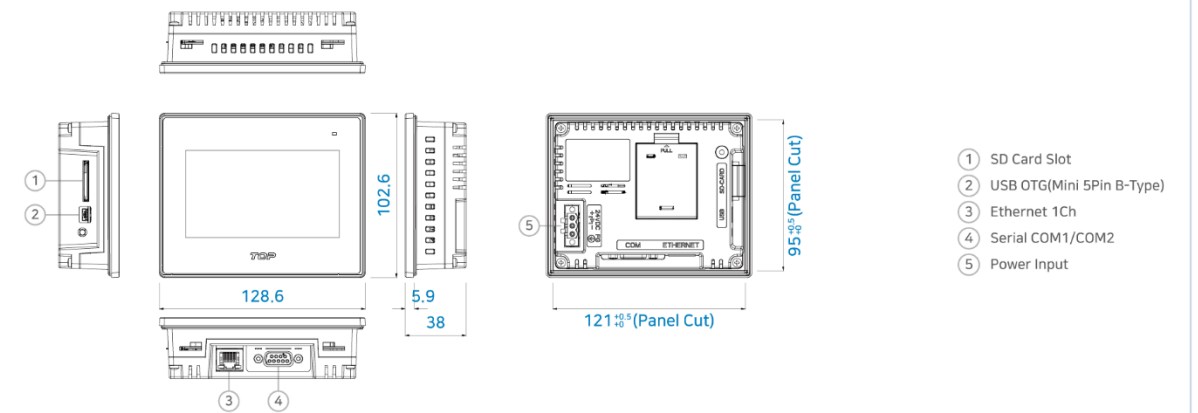



Wireless Handy Type with Ergonomic Designed Hand Grip

TOPRH Wireless Model

EMBEDDED HMI

SMART X HMI



INTERFACE

WiFi | USB HOST 2 PORTS | USB OTG | SD CARD

CERTIFICATION



FEATURES

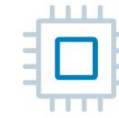

QUAD CORE CPU

Quad core processor supplying rapid processing speed



16M FULL COLOR

Bright and vivid full color, supports vector image library



HIGH PERFORMANCE WIRELESS CHIP

Wireless control features extended control distance



ERGONOMIC AND REFINED DESIGN

Stable and comfortable grip



KEY LOCK/3 POSITION SWITCH /FUNCTION KEYS/TOUCH PENCIL

6 Function keys including LED light, and touch pencil to easy operation



SHOCK PREVENTING BUMPER

Solid body and added silicon bumper for safer use



TOUCH DRAG FEATURE

Available touch drag to make a picture memo or scroll down to appear top-side menu



SUPPORT HIGH RESOLUTION

Support 1024x600 high resolution screen



# TOPRH WIRELESS / CHARGING CRADLE SPECIFICATIONS

Functional		TOPRH0700WD-W
Display	Display Type	7" TFT Color
	Color	16M Colors
	Display Area(mm)	154.21x85.92
	Resolution(dot)	1024x600
	Brightness Level	10 Levels(by software)
	Backlight Type	LED
Touch	Backlight Life	50,000 hours
	Touch Type	Analog resistive film
	Resolution(Cell)	1024x600
	Touch Life	1 million times or more
Wireless LAN		2.4G: 2.4000GHz ~ 2.4835GHz 5G: 5.150GHz ~ 5.725GHz WLAN Standard: IEEE802.11 a/b/g/n Operation Range Up to 150meters in open space Security: WEP, TKIP, AES, WPA, WPA2
	USB Host	USB 2.0 Compatible, Output 5Vdc/0.5A Support: USB Storage, USB Barcode Scanner(Standard Keyboard Protocol) Connector: USB Type A x 2
	USB OTG	USB 2.0 Compatible, Output 5Vdc/0.5A, Max 3m Support: USB Storage, USB Barcode Scanner(Standard Keyboard Protocol) Connector: USB Mini-B x 1
Memory & Others	SD Card	SD Card Slot x 1, SDHC(MAX 32GB)
	Function Key	6Position with LED
	Machanical Switchs	Keylock Switch 1A, 3Position enable Switch OFF-ON-OFF(1CH)
	Power Switch	Push-Push power on-off switch built in
	Screen Memory	128MB
	Backup Memory	512KB: System buffer(10K Word), Including Alarm/Logging/Recipe
	Backup Period	Permanent
	Real Time Clock	Built in
	Status LED	3 LEDs(Power, Operation, Link) Built in
	Battery	Rechargeable & Extractable Battery Pack 2S-2P Li-ion 4Cells 7.2Vdc 6800mAh Charging time 3 hours(Non-operating) Running time: 7 hours with wireless communication
Power	Consumption	20W or less(In Battery Pack)
	Operation Temperature(°C)	+10 ~ +45
	Storage Temperature(°C)	-20 ~ +60
	Operation Humidity(%RH)	0 ~ 90(No dew)
Environment	Atmosphere	No corrosive gas
	Vibration Endurance	Amplitude: 10sF<25Hz(2G) X,Y,Z each direction(for 30 minutes)
	Static Electricity Discharge	Connective discharge from EN61000-4-2: ±4kV
	Shock Endurance	10G X,Y,Z each direction(for 3 times)
	Protection Classification	IP65
	Certification	CE, KC, UL
Structure	External Dimension(mm)	237x205x103
	Weight(kg)	1.32(Including Battery Pack)
	Cooling System	Natural air circulation
Case Material	PC(Resistance to flame)	

Functional		TOPRH-CRDL
Power	Input Voltage	24Vdc(20~28Vdc)
	Output Voltage	8.4Vdc
	Power Consumption	60W or less(with Main Body + Extra Battery Pack)
	Voltage Sag	24Vdc, Within 10ms
Environment	Insulation Resistance	500Vdc, 10MΩ
	Status LED	3 LEDs(Main Battery Pack, Power, Sub Battery Pack) Built in
	Operation Temperature(°C)	-10 ~ +50
	Storage Temperature(°C)	-20 ~ +60
	Operation Humidity(%RH)	0 ~ 90(No dew)
	Atmosphere	No corrosive gas
	Vibration Endurance	Amplitude: 10sF<25Hz(2G) X,Y,Z each direction(for 30 minutes)
	Noise Immunity	1000Vp-p(Pulse width 1μs)
	Static Electricity Discharge	Connective discharge from EN61000-4-2: ±4kV
	Shock Endurance	10G X,Y,Z each direction(for 3 times)
Structure	Ground Connection	Class 3(100Ω under)
	Certification	CE, KC
	External Dimension(mm)	214.5x125x154
	Weight(kg)	0.6
Cooling System	Natural air circulation	
Case Material	PC(Resistance to flame)	

# PRODUCT COMPOSITION

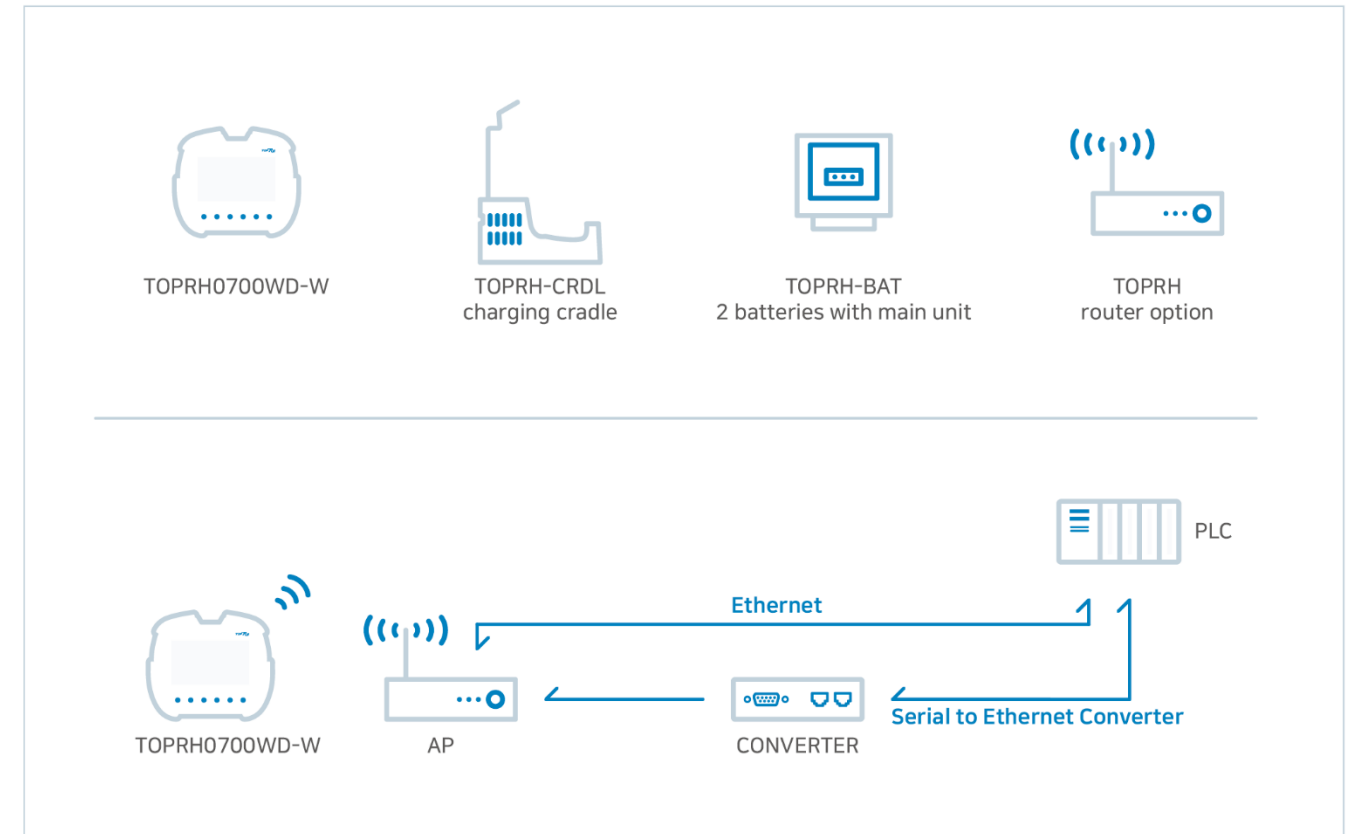

# DRAWING

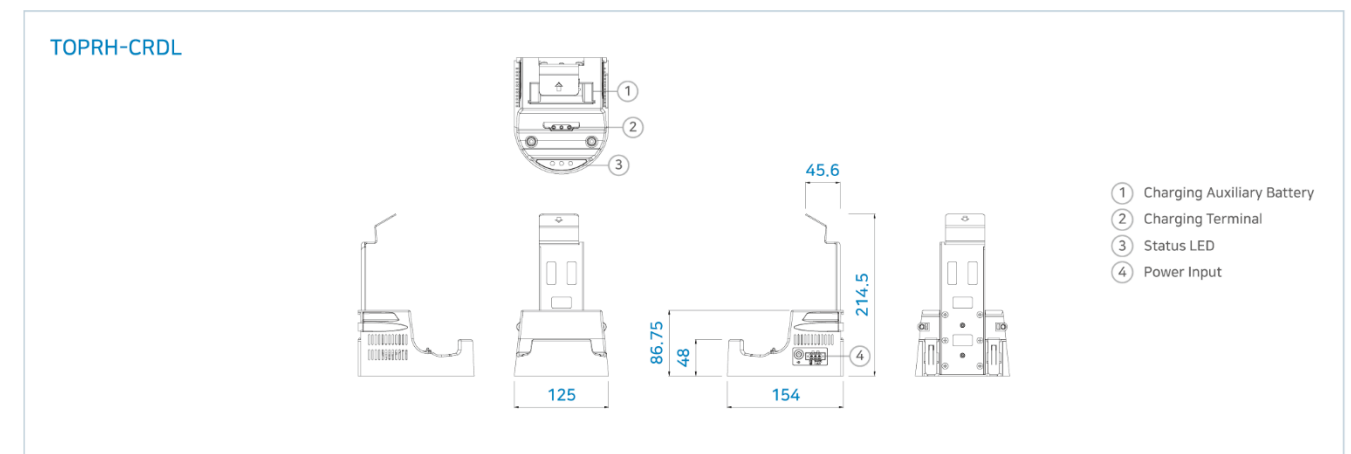
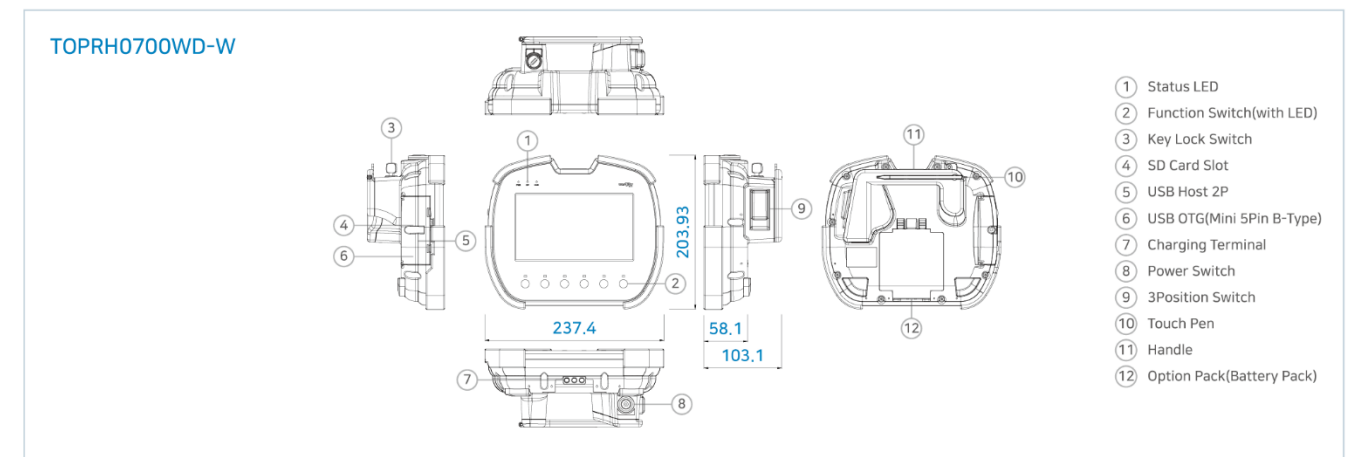



Wired Handy Type with Ergonomic Designed Hand Grip

TOPRH Wired Series

EMBEDDED HMI

SMART X HMI



INTERFACE

SERIAL 2 PORTS | ETHERNET 1 CHANNEL | USB HOST 2 PORTS | USB OTG | SD CARD

CERTIFICATION



FEATURES

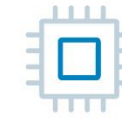

QUAD CORE CPU

Quad core processor supplying rapid processing speed



16M FULL COLOR

Bright and vivid full color, supports vector image library



ERGONOMIC AND REFINED DESIGN

Stable and comfortable grip



KEY LOCK/EMERGENCY /3 POSITION SWITCH

Safe use with KEY lock/Emergency /3 Position switch



FUNCTION KEY, TOUCH PENCIL

6 Function keys including LED light, and touch pencil to easy operation



SHOCK PREVENTING BUMPER

Solid body and added silicon bumper for safer use



TOUCH DRAG FEATURE

Available touch drag to make a picture memo or scroll down to appear top-side menu



SUPPORT HIGH RESOLUTION

Support 1024x600 high resolution screen

# TOPRH WIRED / TOPRHWS SPECIFICATIONS

Functional		TOPRH0700WD FE
Display	Display Type	7" TFT Color
	Color	16M Colors
	Display Area(mm)	154.21x85.92
	Resolution(dot)	1024x600
	Brightness Level	10 Levels(by software)
	Backlight Type	LED
Touch	Backlight Life	50,000 hours
	Touch Type	Analog resistive film
	Resolution(Cell)	1024x600
	Touch Life	1 million times or more
Interface	Serial COM1	RS-232C, RS-422/485 Asynchronous Data bit: 7/8 bits, Stop bit: 1/2 bits, Parity bit: None/Odd/Even, Baud rate: 2400~115.2kbps
	Serial COM2	RS-232C, RS-422/485 Asynchronous Data bit: 7/8 bits, Stop bit: 1/2 bits, Parity bit: None/Odd/Even, Baud rate: 2400~115.2kbps
	Ethernet	IEEE802.3i/IEEE802.3u, 10BASE-T/100BASE-TX
	USB Host	USB 2.0 Compatible, Output 5Vdc/0.5A Support: USB Storage, USB Barcode Scanner(Standard Keyboard Protocol) Connector: USB Type A x 2
	USB OTG	USB 2.0 Compatible, Output 5Vdc/0.5A, Max 3m Support: USB Storage, USB Barcode Scanner(Standard Keyboard Protocol) Connector: USB Mini-B x 1
	SD Card	SD Card Slot x 1, SDHC(MAX 32GB)
	Function Key	6Position with LED
	Printer	Roll Printer(EPSON protocol): RS-232C
	Machanical Switchs	Emergency Switch 1A-2B, Keylock Switch 1A, 3Position enable Switch OFF-ON-OFF(2CH)
	Power Switch	Push-Lock power on-off switch built in
Memory & Others	Screen Memory	128MB
	Backup Memory	512KB: System buffer(10K Word), Including Alarm/Logging/Recipe
	Backup Period	Permanent
	Real Time Clock	Built in
Power	Status LED	3 LEDs(Power, Operation, Link) Built in
	Consumption	20W or less
	Voltage Sag	24Vdc, Within 10ms
	Insulation Resistance	500Vdc, 10MΩ
	Operation Temperature(°C)	-10 ~ +45
	Storage Temperature(°C)	-20 ~ +60
	Operation Humidity(%RH)	0 ~ 90(No dew)
	Atmosphere	No corrosive gas
	Vibration Endurance	Amplitude: 10≤F < 25Hz(2G) X,Y,Z each direction(for 30 minutes)
	Noise Immunity	1000Vp-p(Pulse width 1μs)
Environment	Static Electricity Discharge	Connective discharge from EN61000-4-2: ±4kV
	Shock Endurance	10G X,Y,Z each direction(for 3 times)
	Ground Connection	Class 3(100Ω under)
	Protection Classification	IP4X
	Certification	CE, KC
	External Dimension(mm)	237x205x103
	Weight(kg)	1.1(Except Cable Pack)
	Cooling System	Natural air circulation
	Case Material	PC(Resistance to flame)

Functional		TOPRHWS	TOPRHWS02
Interface	Serial COM1	RS-232C, RS-422/485 Asynchronous Data bit: 7/8 bits, Stop bit: 1/2 bits, Parity bit: None/Odd/Even Baud rate: 2400~115.2kbps, Connector: DSUB 9pin x 1	
	Ethernet	IEEE802.3i/IEEE802.3u, 10BASE-T/100BASE-TX, Connector: RJ-45 x 1	
	Power Switch	Push-Push power on-off switch built in	
	26P Connector	To TOPRH, SRC6A21-26P	To TOPRH, 1981919-1 or 1981921-1
Power	Function Connector	Emergency Switch 1A-2B, Keylock Switch 1A, 3Position enable Switch OFF-ON-OFF(2CH), DOU(6CH)	
	Input Voltage	24Vdc(20~28Vdc)	
	Power Consumption	20W or less	
	Voltage Sag	24Vdc, Within 10ms	
	Insulation Resistance	500Vdc, 10MΩ	
	Operation Temperature(°C)	-10 ~ +50	
Environment	Storage Temperature(°C)	-20 ~ +60	
	Operation Humidity(%RH)	0 ~ 90(No dew)	
	Atmosphere	No corrosive gas	
	Vibration Endurance	Amplitude: 10≤F < 25Hz(2G) X,Y,Z each direction(for 30 minutes)	
	Noise Immunity	1000Vp-p(Pulse width 1μs)	
	Static Electricity Discharge	Connective discharge from EN61000-4-2: ±4kV	
	Shock Endurance	10G X,Y,Z each direction(for 3 times)	
	Ground Connection	Class 3(100Ω under)	
	Certification	CE, KC	
	External Dimension(mm)	145x119x54	148x119x54
Structure	Weight(kg)	0.3	
	Cooling System	Natural air circulation	
	Case Material	PC(Resistance to flame)	

# PRODUCT COMPOSITION

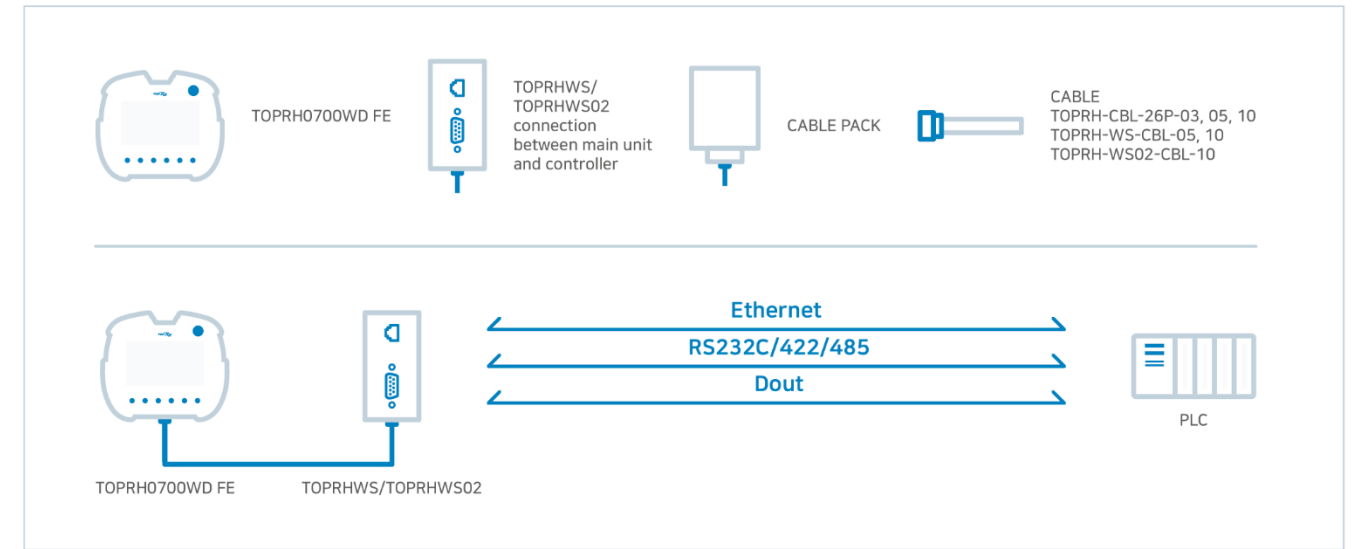

# DRAWING

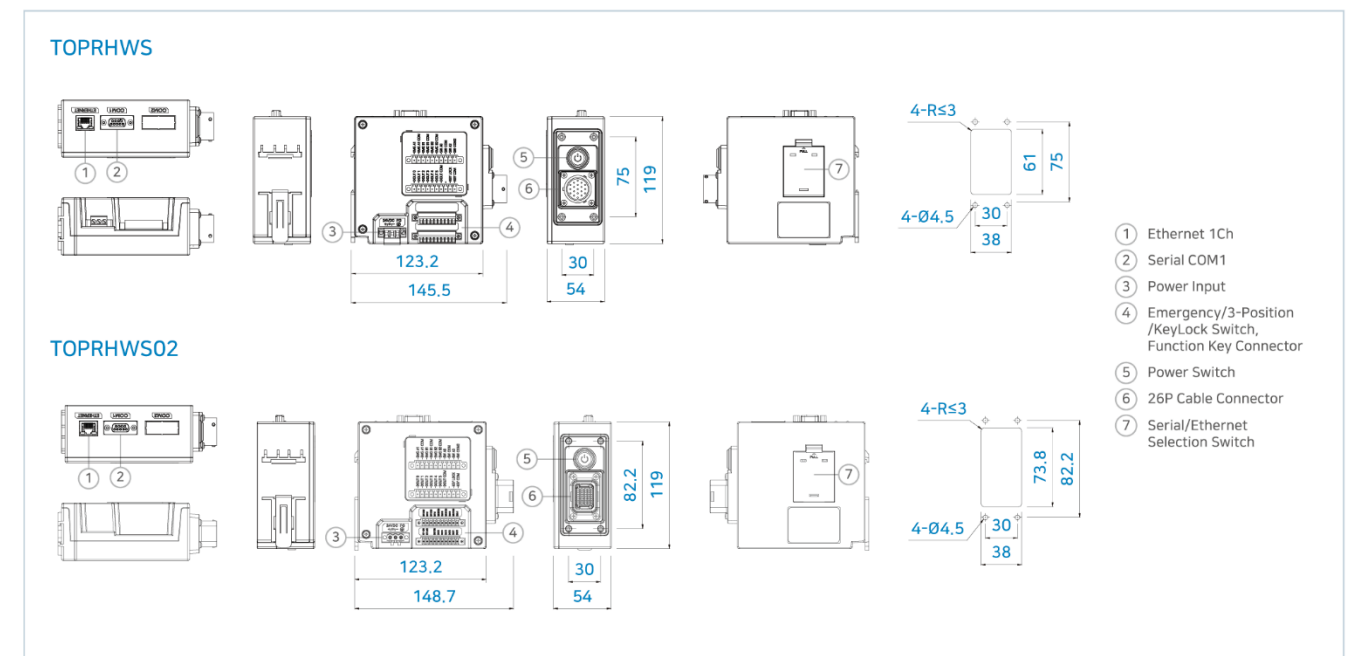
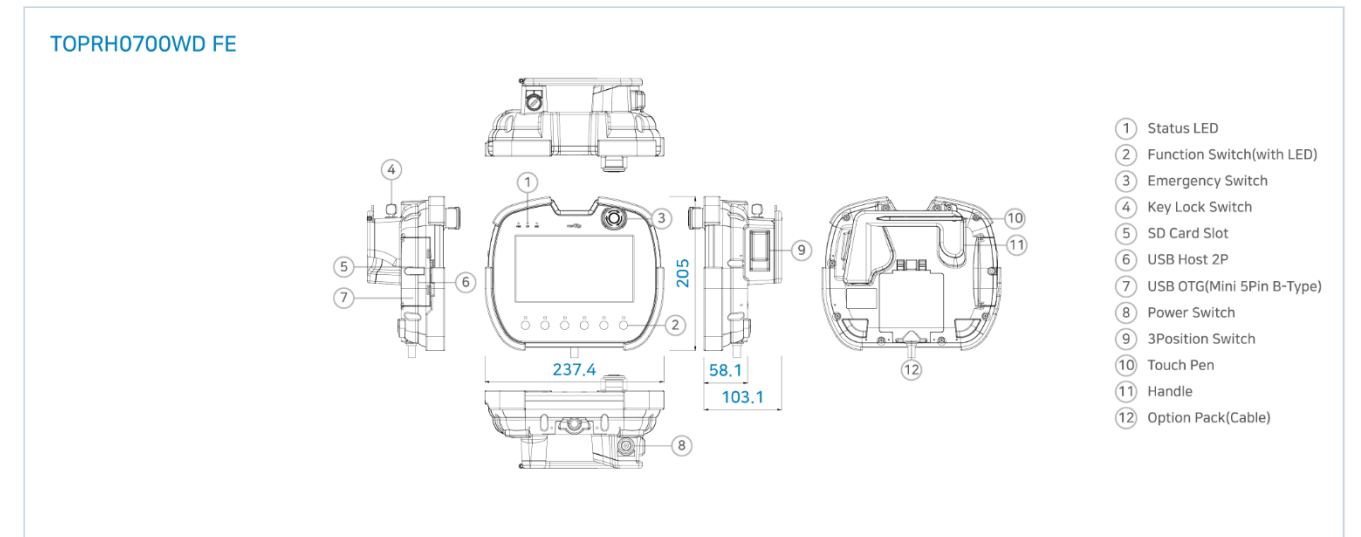





Miniaturized New Form Factor,  
Smaller and Simple

**TOPRP Series**

BOX HMI

SMART X HMI



Model: TOPRP1000D

**INTERFACE**

SERIAL 2 PORTS | ETHERNET 2 CHANNEL | USB HOST 2 PORTS | USB OTG | SD CARD | HDMI OUT

**CERTIFICATION**



**FEATURES**



**MINIATURIZED BODY FRAME**

Small size able to install in a minimum space



**STANDARD DIN RAIL /VESA HALL SUPPORTED**

Easy installation by standard DIN rail  
simple assemble with monitors by standard VESA bracket(\*Option)



**HDMI OUTPUT**

Connection with various monitors through HDMI and DP  
M2I's exclusive touch monitor(MDP) compatible



**COMPATIBILITY WITH TOP SERIES**

Quad core cpu supplying rapid processing speed  
Same menu and instructions as TOP series



**SUPPORTING ETHERNET 2 CHANNELS**

2 Ethernet channels with different IP  
VNC(Remote Monitor/Control)  
Function Support



**SUPPORTING SERIAL 2 PORTS**

COM1/COM2 DSUB 9pin  
RS-232C, RS-422/485 support



**SUPPORTING USB HOST 2 PORTS**

Connecting mouse, keyboard, USB memory, barcode scanner etc.



**OTG USB**

Mode switch between transmission mode (Program transfer) and host mode (Connecting USB devices as mouse, keyboard, USB memory, barcode scanner etc.)

# TOPRP SPECIFICATIONS

Functional	TOPRP1000D
Interface	Serial COM1 RS-232C, RS-422/485 Asynchronous +5Vdc PWR Data bit: 7/8 bits, Stop bit: 1/2 bits, Parity bit: None/Odd/Even Baud rate: 2400~115.2kbps Connector: DSUB 9pin x 1
	Serial COM2 RS-232C, RS-422/485 Asynchronous Data bit: 7/8 bits, Stop bit: 1/2 bits, Parity bit: None/Odd/Even Baud rate: 2400~115.2kbps Connector: DSUB 9pin x 1
	Ethernet IEEE802.3i/IEEE802.3u, 10BASE-T/100BASE-TX Connector: RJ-45 x 2
	USB Host USB 2.0 Compatible, Output 5Vdc/0.5A Support: USB Storage, USB Barcode Scanner(Standard Keyboard Protocol) Connector: USB Type A x 2
	USB OTG USB 2.0 Compatible, Output 5Vdc/0.5A, Max 3m Support: USB Storage, USB Barcode Scanner(Standard Keyboard Protocol) Connector: USB Mini-B x 1
Memory & Others	SD Card SD Card Slot x 1, SDHC(MAX 32GB)
	HDMI Output HDMI v1.4, HDMI Output, Max. Resolution: 1280x720 at 60Hz Connector: HDMI x 1
	Printer Roll Printer(EPSON protocol): RS-232C
	Screen Memory 128MB
	Backup Memory 512KB: System buffer(10K Word), Including Alarm/Logging/Recipe
Power	Backup Period Permanent
	Real Time Clock Built in
	Status LED 3 LEDs(Power, Operation, SD Card) Built in
	Input Voltage 24Vdc(20~28Vdc)
	Power Consumption 10W or less
Environment	Voltage Sag 24Vdc, Within 10ms
	Insulation Resistance 500Vdc, 10MΩ
	Operation Temperature(°C) -10 ~ +50
	Storage Temperature(°C) -20 ~ +60
	Operation Humidity(%RH) 0 ~ 90(No dew)
Structure	Atmosphere No corrosive gas
	Vibration Endurance Amplitude: 10≤F<25Hz(2G) X,Y,Z each direction(for 30 minutes)
	Noise Immunity 1000Vp-p(Pulse width 1μs)
	Electrostatic Discharge Connective discharge from EN61000-4-2: ±4kV
	Shock Endurance 10G X,Y,Z each direction(for 3 times)
Structure	Ground Connection Class 3(100Ω or less)
	Protection Classification IP20
	Certification CE, KC
	External Dimension(mm) 128.9x131.2x29.2
	Weight(kg) 0.23
Structure	Installation Method Standard DIN Rail(35mm), VESA
	Cooling System Natural air circulation
	Case Material Plastic

# DRAWING

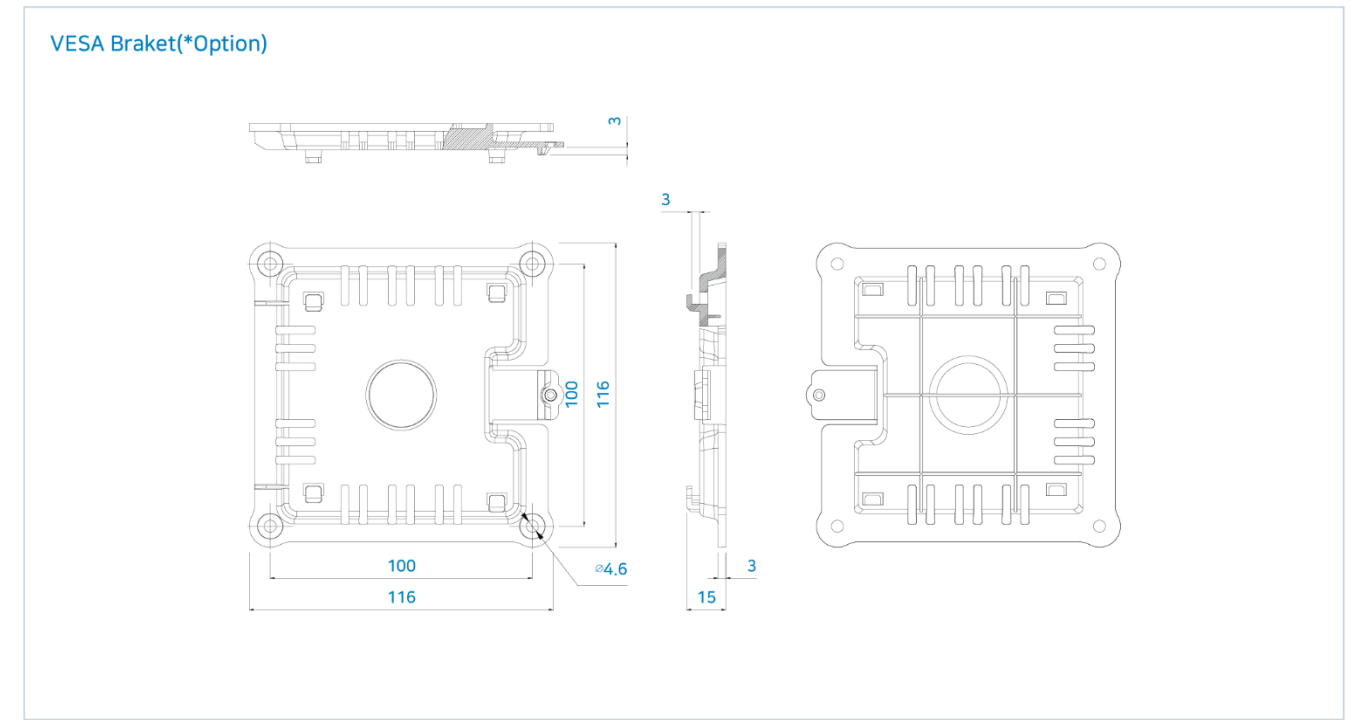
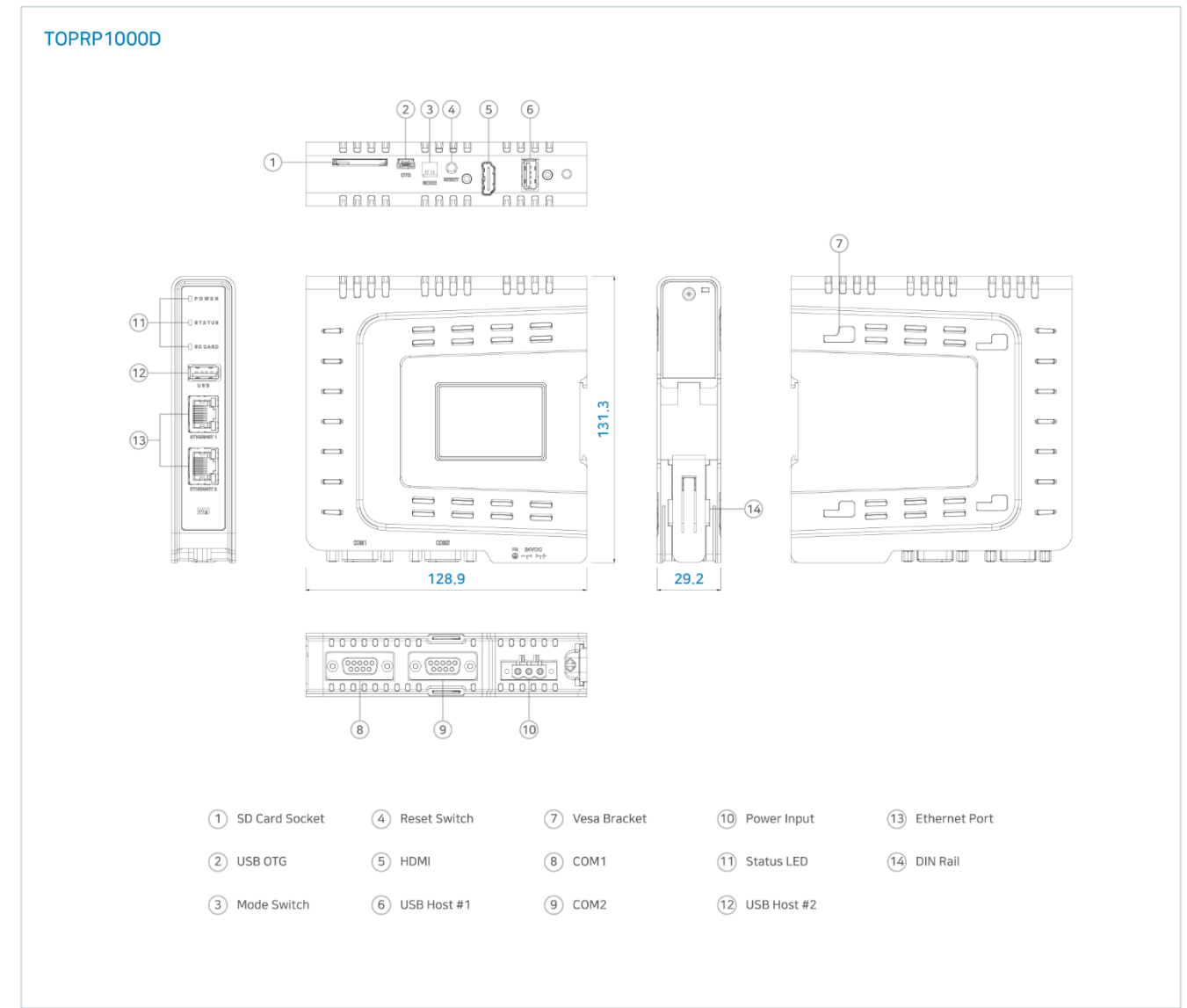



## 2 Channel KVM Touch Monitor with Capacitive Touch and FHD LCD

MDP Series

2CH KVM TOUCH MONITOR

TOUCH MONITOR



### INTERFACE

HDMI 2 PORTS | USB UP STREAM 2 PORTS | USB DOWN STREAM 2 PORTS

### CERTIFICATION



### FEATURES



#### 2 CHANNEL TOUCH MONITOR

Industrial 2 channel touch monitor  
Display channel switching by touch button



#### EXPLOSION-PROOF STRUCTURE

The first monitor which has explosion-proof structure



#### CAPACITIVE TOUCH

Clear display with capacitive touch  
IK7 grade tempered glass



#### FHD LCD

16 : 9, 19 inch, FHD LCD(1920 x 1080)



#### FRONT USB PORT

Connection ports to connect Mouse, Keyboard, USB Memory, Barcode Reader



#### ALUMINUM FRAME

Strong durability and refined design of aluminum body



#### HDMI/USB INTERFACE

HDMI 2 Channels  
USB 2 Channels(UP 2 ports, DOWN 3 ports)



#### VESA HALL ON REAR SIDE

Convenient attachment with M2I's box HMI and box PC



# MDP SPECIFICATIONS

Functional	MDP-DC1900WD	
Display	Display Type	18.5" TFT Color
	Backlight Life	50000 hour
	Aspect Ratio	16 : 9
	Color	16M
	Viewing Angle(H/V)	89/89/89/89
	Contrast Ratio	1000 : 1
	Response Time	20ms
	Brightness	350Cd/m2
Touch	Recommend Resolution	1920 x 1080
	Touch Type	Capacitive touch
Interface	HDMI Input	2 Ports
	USB Up Stream	USB Type B x 2(Rear x 2)
	USB Down Stream	USB Type A x 3(Front x 1, Rear x 2)
OSD Controls	Capacitive Touch Button	KVM/Up/Down/Menu, Select/Power
	Input Voltage	24Vdc(20~28Vcd)
Power	Power Consumption	40W or less
	Voltage Sag	24Vdc, Within 10ms
	Insulation Resistance	500Vdc, 10MΩ
	Operation Temperature(°C)	-10 ~ +50
Environment	Storage Temperature(°C)	-20 ~ +60
	Operation Humidity(%RH)	0 ~ 90(No dew)
	Noise Immunity	1000Vp-p(Pulse width 1μs)
	Static Electricity Discharge	Connective discharge from EN61000-4-2: ±4kV
	Shock Endurance	10G X, Y, Z each direction(for 3 times)
	Ground Connection	Class 3(100Ω or less)
	Protection Classification	IP65(Front)
	Certification	CE, KC
Structure	Panel Cut(mm)	463 x 314
	External Dimension(mm)	477.4 x 328.4 x 63.5
	Weight(kg)	5.0
	Cooling System	Natural air circulation
	Case Material	Aluminum + Plastic
	VESA Wall Mount Holes(mm)	100 x 100

# DRAWING

MDP-DC1900WD

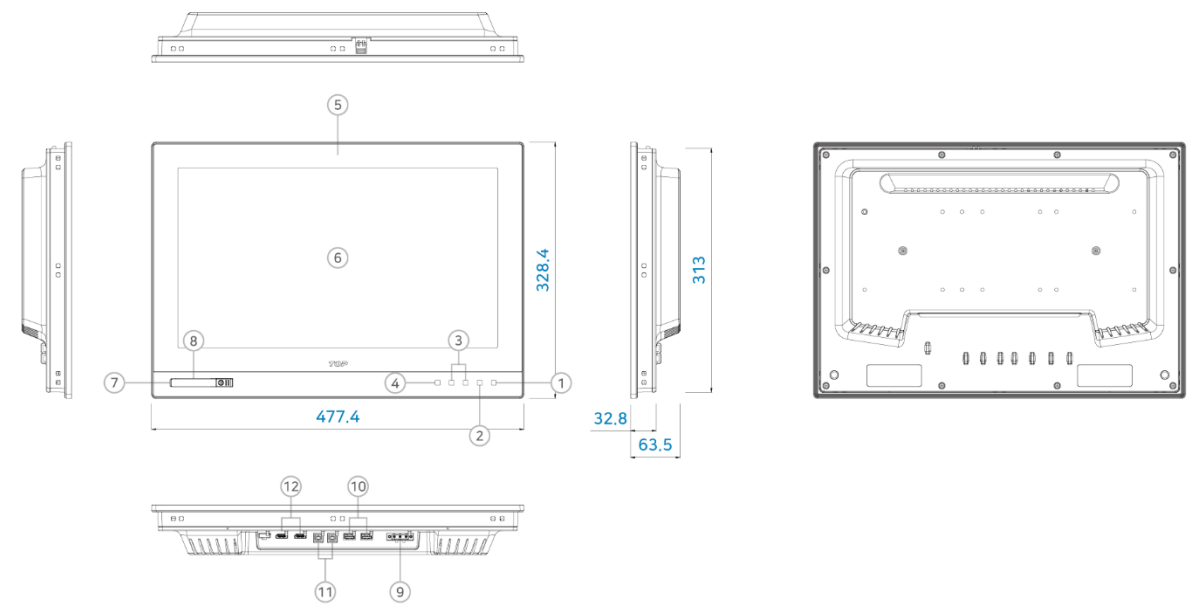

- ① Power LED & Button
- ② OSD MENU Button
- ③ Up/Down Button
- ④ Display Change Button
- ⑤ LCD Panel
- ⑥ Touch Panel
- ⑦ USB Cover
- ⑧ USB Downstream Port 3
- ⑨ Power Input
- ⑩ USB Downstream Port 1, 2
- ⑪ USB Upstream Port 1, 2
- ⑫ HDMI Input 1, 2

## Agency Introduction

HMI Specialized Company

- More than 20 oversea sales agencies



China, Japan, Singapore, India, Turkey, Vietnam, Israel, Malaysia, Thailand, Greece, France, Iran, Jordan, etc.

- More than 36 domestic sales agencies

### Headquarters

Gyeonggi-do Anyang-si

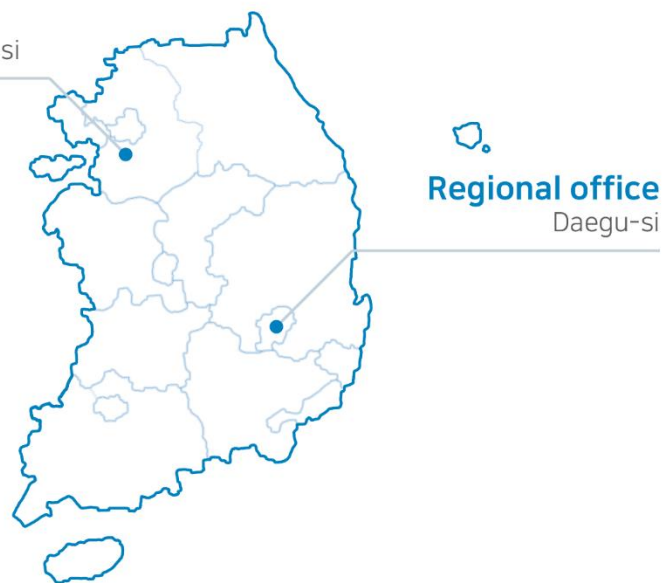

Regional office  
Daegu-si

Seoul, Gyeonggi, Daejeon, Daegu, Gwangju, Ulsan, Changwon, Busan, etc.

## Promise to Customer

HMI Specialized Company

PROMISE

**M2** Corporation  
Man · Machine · Interface

01



PROMISE 1

### Communicating(Interact) with Customer

Customer to be first, on their side

02

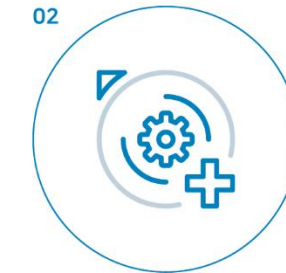

PROMISE 2

### Continuous Growth

Constant development, improvement of reliability and productivity

03

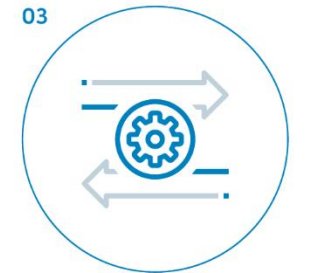

PROMISE 3

### Brand New Change

Change to become leader of field of Smart Factory Automation

For customer's satisfaction, M2I will keep communicate, to improve quality of product, M2I will keep research and develop no fear to change.

We are M2I,  
the **HMI Specialized Company**